

AXEL

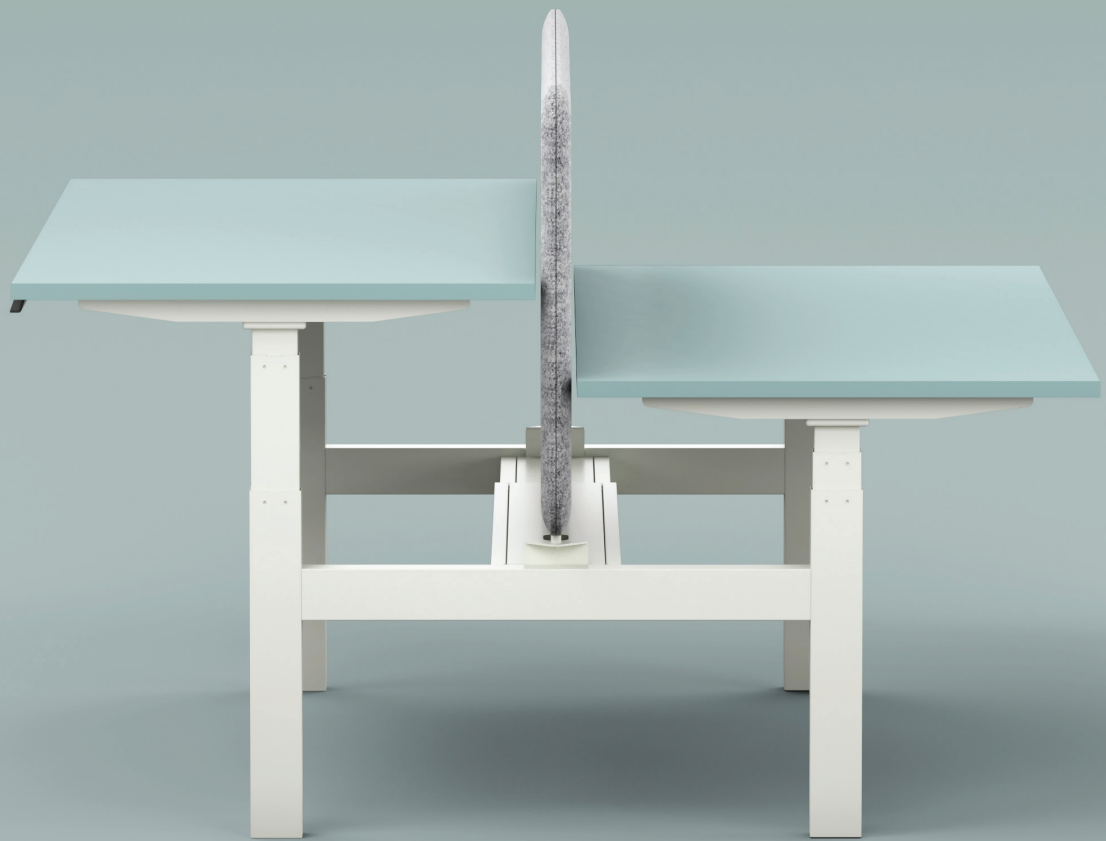

Signature
— BY EOL —



COMPLÈTE & ERGONOMIQUE

Gâce à son système de réglage motorisé ou par manivelle, AXEL permet de changer facilement de position au cours de la journée pour améliorer le bien-être et la productivité de l'utilisateur. AXEL s'intègre à tous les environnements en version poste individuel ou partagé. Pour une garantie de confort et de sécurité, le modèle motorisé est équipé d'une commande à mémoire de position et d'un système anticollision.

ADAPTABLE & ERGONOMIC

Thanks to its manual or electrically powered height adjustment systems, AXEL allows users to modify their working position throughout the day, helping to improve the well-being of staff and encourage productivity. With a choice between manual and electrically powered height adjustment systems on individual or shared workstation configurations, AXEL desks are perfectly adapted to a wide variety of work environments. To ensure optimal levels of comfort and safety the electric powered model features a digital control panel with position memory settings and an anti-collision system.

COMPLEET & ERGONOMISCH

Dankzij de elektrische hoogteregeling of hoogteregeling met hendel biedt AXEL de mogelijkheid om in de loop van de dag van positie te veranderen, wat bijdraagt tot het welzijn en de productiviteit van de gebruiker. AXEL is voorzien van een hoogteregeling met hendel of elektrisch en is leverbaar als vrijstaand of gedeeld bureau. Voor gewaarborgd comfort en veiligheid is het elektrisch bediende model voorzien van een geheugenfunctie en een veiligheidsstop.

SOLUTIONS ASSIS-DEBOUT POUR TOUS
SIT-STAND SOLUTIONS FOR EVERYONE
ZITTEND-STAAW WERKEN VOOR IEDEREEN



Bureaux individuels, réglage par manivelle
Individual workstations, hand lever operated
Vrijstaand bureau, hoogteregeling met hendel



ou par système motorisé
or electrically powered height adjustment
of elektrische hoogteregeling



Bureau bench avec réglage par système motorisé (existe aussi avec réglage par manivelle)
Bench workstation with electrically powered height adjustment (also available with hand lever operated system)
Bench bureau met elektrische hoogteregeling (eveneens leverbaar met hendel)

PERSONNALISER AXEL
CUSTOMIZE AXEL
AXEL PERSONALISEREN



AXEL propose de nombreuses configurations de bureaux individuels ou partagés qui s'adaptent à tous les types d'aménagement. Des options existent pour créer l'AXEL dont vous avez besoin : 2 types de réglages ainsi qu'une large sélection d'accessoires et de solutions d'électrification.

AXEL offers the possibility of multiple individual and shared workstation configurations that will sit comfortably within any workspace. Whatever your needs, there's an AXEL solution for you: 2 types of height adjustment system, as well as an extensive selection of accessories and cable management solutions.

AXEL kan opgesteld worden als individueel of gedeeld bureau en past zich aan elke inrichtingsstijl aan. AXEL kan ook aangevuld worden met verschillende opties: 2 types hoogteregelingen en een ruime keuze van accessoires en oplossingen voor kabelgeleiding.

Systèmes de réglages - Height adjustment systems - Regelsystemen



Par manivelle : réglage de 715 à 1170 (bureau individuel) et de 715 à 1160 mm (bureau bench)
Manivelle extractible pour le réglage
Se positionne uniquement à droite du plan de travail

Manual - by hand lever: adjusts from 715 to 1170 mm (individual desk) and from 715 to 1160 mm (bench shared desk)
Retractable lever for manual height-adjustments
Sits to the right-hand side of the main work surface

Met hendel: hoogteregeling tussen 715 en 1170 mm (individueel bureau) en tussen 715 en 1160 mm (bench bureau)
Afneembare regelhendel
De hendel bevindt zich rechts onder het werkblad



Par système motorisé : réglage de 650 à 1300 mm avec boîtier de commande numérique 4 mémoires de positions
Système anticollision intégré

Powered - by electric motor: adjusts from 650 to 1300 mm with a built-in digital control panel and a memory for 4 pre-set positions
Integrated anti-collision technology

Elektrisch hoogteregeling tussen 650 en 1300 mm via digitaal bedieningspaneel met geheugenfunctie voor 4 posities
Geïntegreerde veiligheidsstop



Panneau écran acoustique spécifique H. 700 mm pour bench AXEL
Acoustic desktop screen H. 700 mm for AXEL shared bench workstations
Geluiddempend privacy-paneel H. 700 mm voor bench bureaus AXEL



Panneau écran pour postes individuels*
Desktop screen for individual workstations*
Privacy-paneel voor individuele bureaus*



Tiroir métal avec plumier
Metal drawer with pen tray
Metalen lade met pennenbakje



Vide poche ABS pivotant **
Rotatable storage tray made from ABS **
Draibaar ABS opbergbakje **



Voile de fond métal
Metal modesty panel
Metalen frontpaneel

*Voir fiche panneaux écrans SOLANGE - *See SOLANGE desktop screen product information sheet - *Zie fiche privacy-panels SOLANGE

**Visuel non contractuel - **Incorrect visual - **Afbeelding niet-conform



Obturateur EOL
EOL cable port
EOL kabeldop



Montée de câbles extensible
Extendable vertical cable channel
Uittrekbare kabelkoker

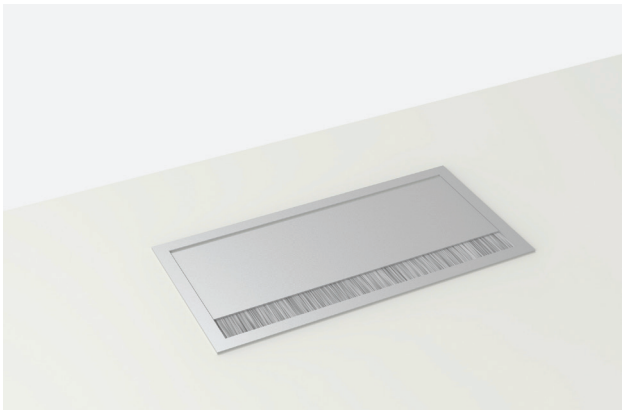

Trappe soft closing sans nourrice
Soft closing top access housing without socket feed
Soft closing luik zonder voeding



Trappe soft closing avec nourrice
Soft closing top access housing with socket feed
Soft closing luik met voeding

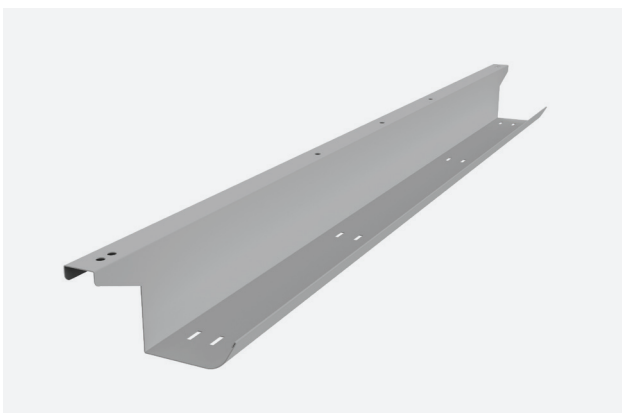

Goulotte simple pour postes individuels
Standard cable trough for individual workstations
Enkele kabelgoot voor individuele bureaus



Goulotte double incluse dans la version bench. Accès aux câbles et boîtier-prises grâce à un capot coulissant
Twin compartment cable trough included in bench desk version. Cables and sockets accessible through a sliding cover
Dubbele kabelgoot meegeleverd met de bench versie. Kabels en stekkerdozen zijn toegankelijk onder een schuifdeksel

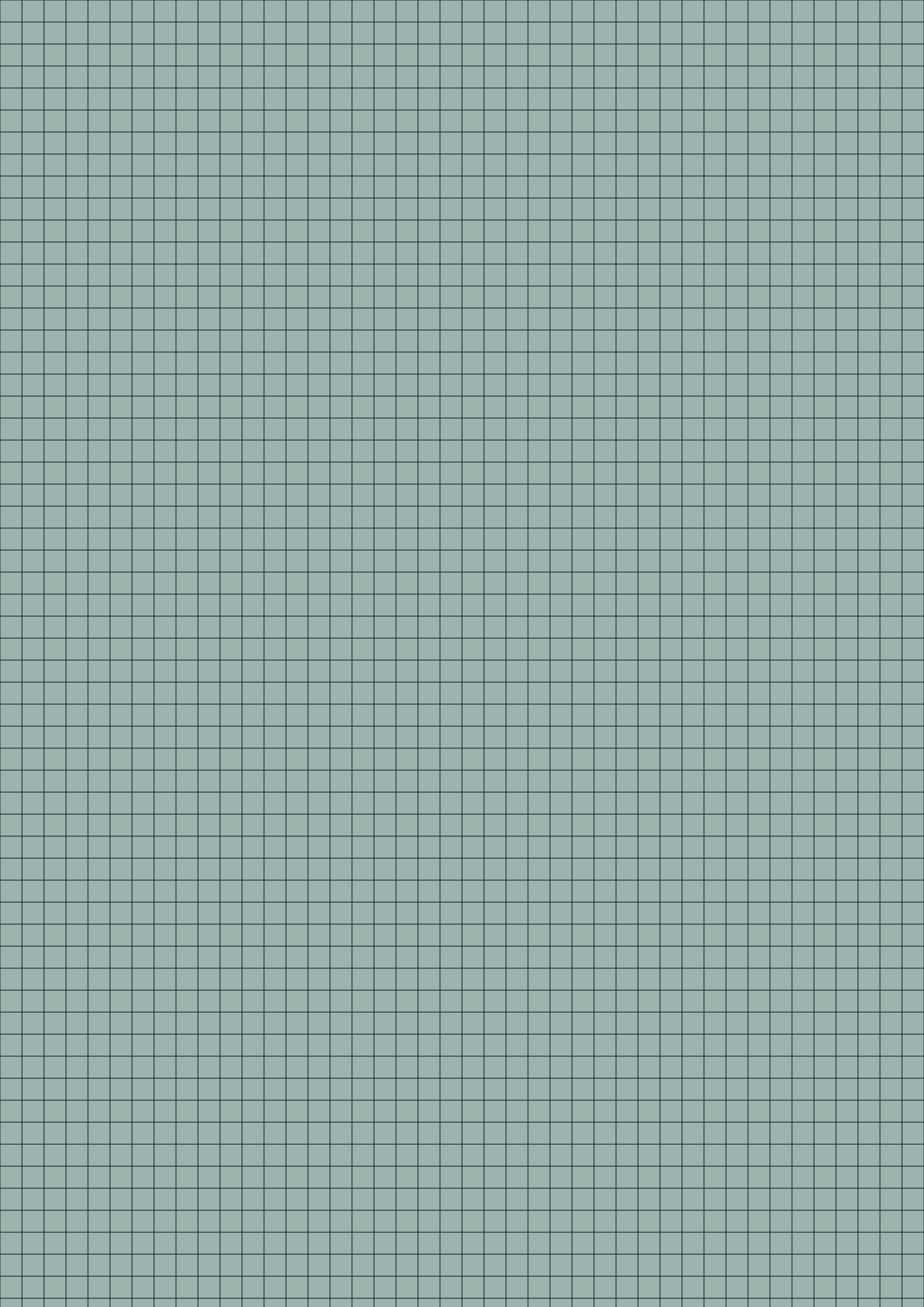

SYNTHÈSE & DIMENSIONS

—

SUMMARY & DIMENSIONS

OVERZICHT & AFMETINGEN

GAMME RANGE COLLECTIE

Plateaux - Worktops - Bladen

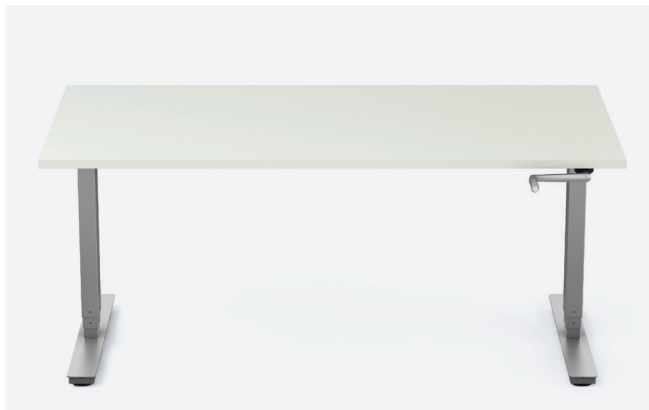

Rectangulaires
Rectangular
Rechthoekig

Piétements - Legs - Onderstellen

Réglage par manivelle de 715 à 1170 mm (bureau individuel) et de 715 à 1160 mm (bureau bench).

Piétements centrés 2 bras télescopiques

Manual adjustment by hand lever: adjusts from 715 to 1170 mm (individual desk) and from 715 to 1160 mm (bench shared desk). Height-adjustable perimeter leg constructed around 2 telescopic shafts

Hoogteregeling met hendel tussen 715 en 1170 mm (individueel bureau) en tussen 715 en 1160 mm (bench bureau).

Centrale poten met 2 telescopische segmenten



Bureau individuel
Individual workstation
Individueel bureau



Bureau bench
Bench workstation
Bench bureau

Réglage par système motorisé de 650 à 1300 mm. Piétements centrés 3 bras télescopiques

Power assisted height adjustment by means of an electric motor, from 650 to 1300 mm. Height-adjustable perimeter leg constructed around 3 telescopic shafts

Elektrische hoogteregeling tussen 650 en 1300 mm. Centrale poten met 3 telescopische segmenten



Bureau individuel
Individual workstation
Individueel bureau



Bureau bench
Bench workstation
Bench bureau

Panneaux écrans acoustiques pour bench AXEL – Acoustic desktop screen for AXEL bench desks – Geluiddempend privacy-paneel voor bench AXEL



Panneau H. 700 mm et pinces de fixation*
Desktop screen H. 700 mm and fixing clamps*
Paneel H. 700 mm en bevestigingsklemmen*

*Pinces de fixation vendues séparément - *Fixing clamps to be ordered separately - *Bevestigingsklemmen afzonderlijk verkocht

SYNOPTIQUE OVERVIEW OVERZICHT

Plateaux poste individuel - Worktops for individual workstations - Individuele bureaus

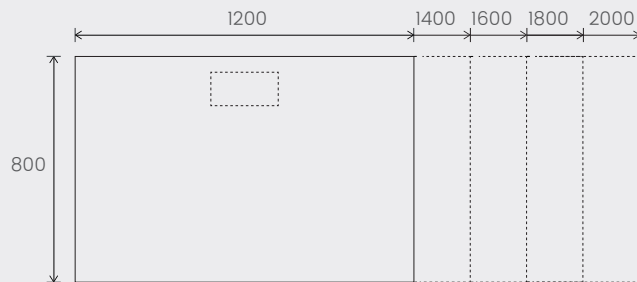

Plateaux postes partagés - Worktops for shared bench workstations - Bench bureaus

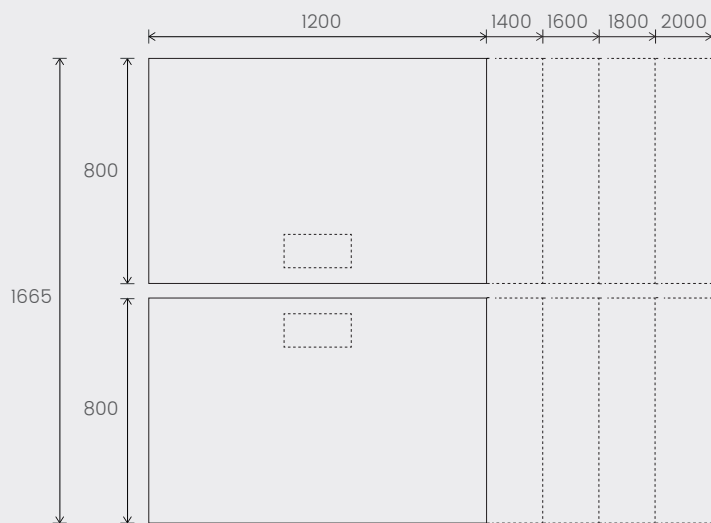

Piétements - Legs - Onderstellen

Réglage par manivelle - Manual leg height adjustment - Hoogteregeling met hendel

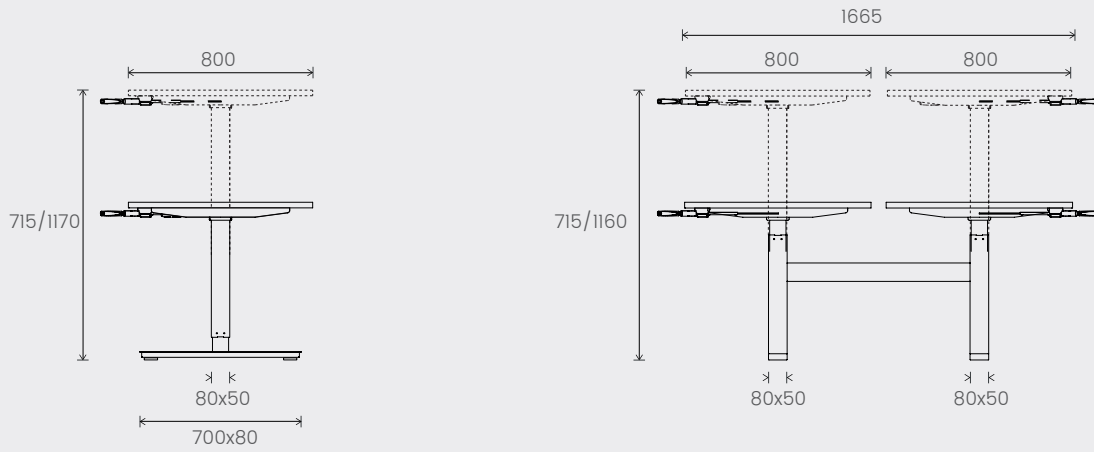

Réglage par système motorisé - Power assisted leg height adjustment system - Elektrische hoogteregeling

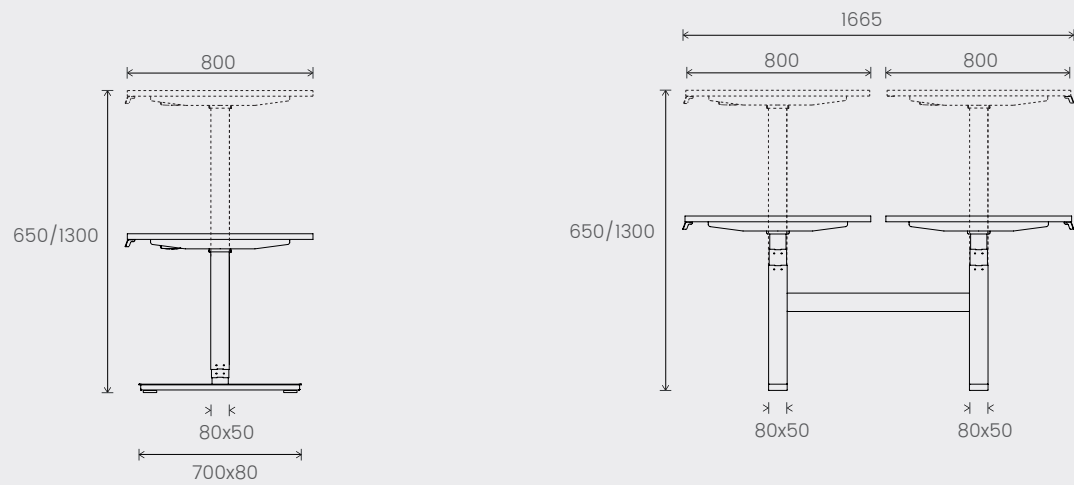

Panneau écran acoustique pour bench AXEL – Acoustic desktop screen for AXEL bench desks –
Geluiddempend privacy-paneel voor bench AXEL

Réglage par manivelle – Manual leg height adjustment – Hoogteregeling met hendel

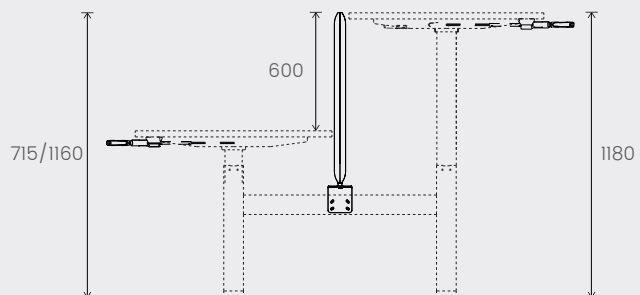

Réglage par système motorisé – Power assisted leg height adjustment system – Elektrische hoogteregeling

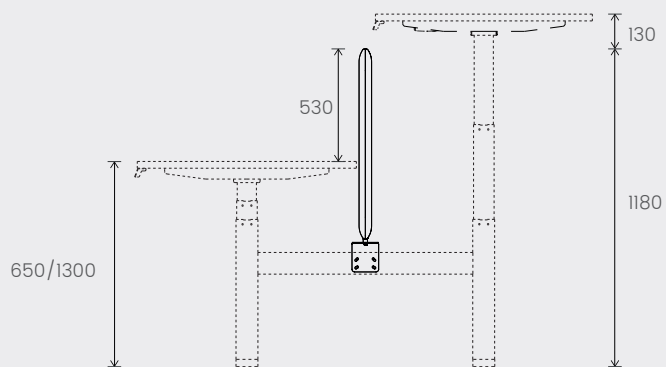

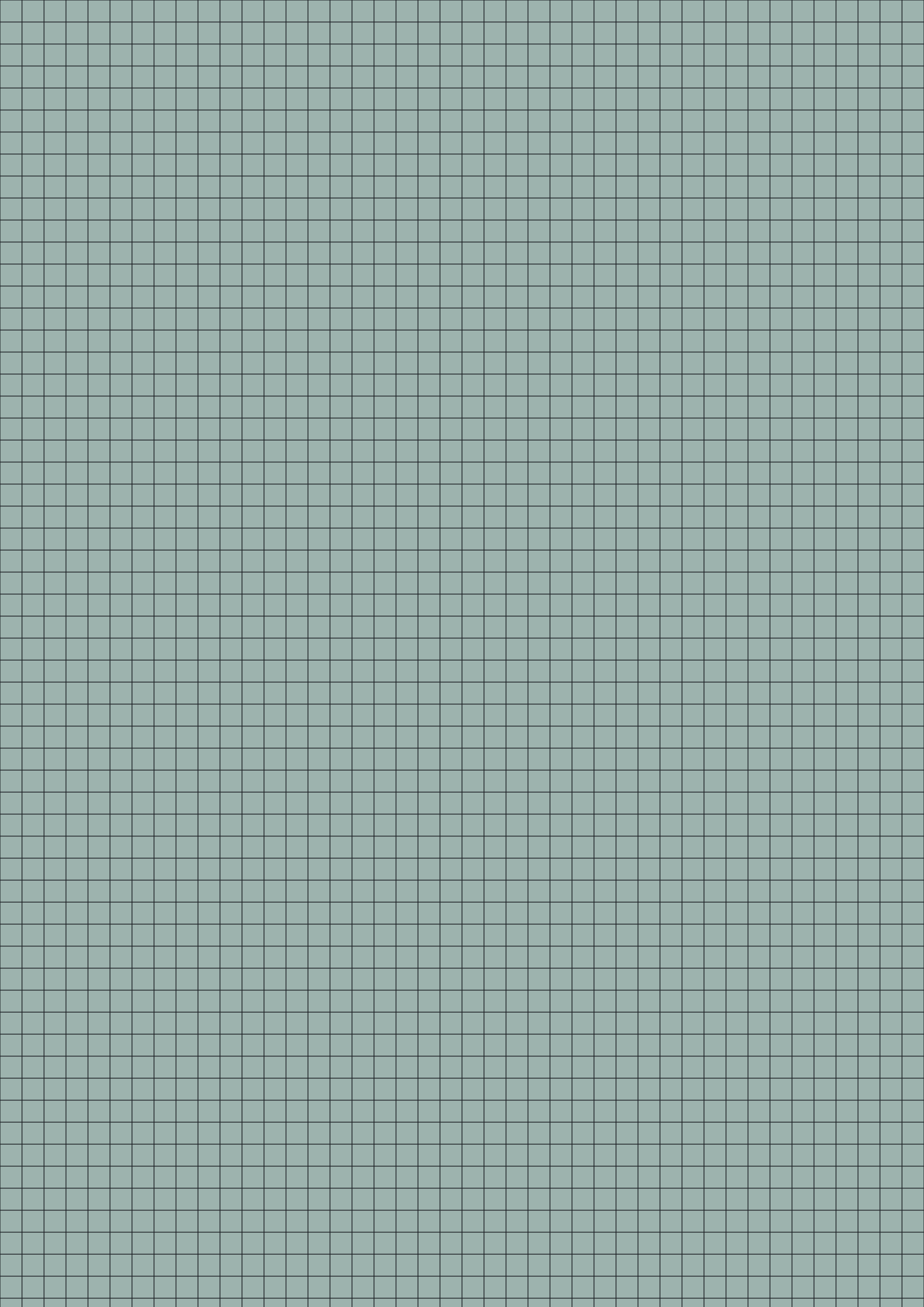

MATIÈRES & COULEURS

—

MATERIALS & COLOURS

MATERIALEN & KLEUREN

1. MÉLAMINE (Plateaux ép. 25 mm) – MELAMINE (Worktops 25 mm thick) – MELAMINE (Bladdikte 25 mm)



MG | Blanc neige
Snow white
Sneeuw wit



MA | Érable blanc*
White maple*
Wit esdoorn*



RI | Chêne clair
Light oak
Licht eiken



RH | Pommier de France*
French apple*
Frans appelhout*



RL | Noyer ambré*
Amber walnut*
Amber notenhout*



MT | Chêne royal brun
Royal brown oak
Royal bruin eiken



M5 | Gris brume
Mist grey
Nevel grijs



M6 | Gris cachemire
Cashmere grey
Kasjmier grijs

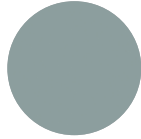

M7 | Vert fjord
Fjord green
Fjord groen



RZ | Acacia de Lakeland
Lakeland acacia
Lakeland acacia



M8 | Chêne gris
Grey oak
Grijs eiken

* Sur demande pour les plateaux découpés pour trappe. – * On request for worktops with pre-cut openings for top-access housings.
– * Met levertijd voor de bladen met perforatie voor luik.

2. MÉTAL (Piétements) – METAL (Legs) – METAAL (Onderstel)

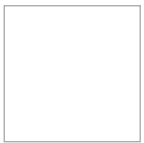

SO | Blanc
White
Wit



Z4 | Gris argent
Silver grey
Zilver grijs



SG | Noir
Black
Zwart

3. MÉTAL (Tiroirs, voiles de fond, goulottes individuelles) – METAL (Drawers, modesty panels, standard cable troughs) – METAAL (Laden, frontpanelen, Individuele kabelgoten)



SO | Blanc
White
Wit

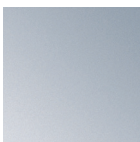

SA | Gris aluminium
Aluminium grey
Alugrijs

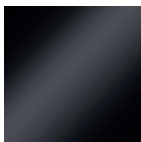

SG | Noir
Black
Zwart

4. TISSUS (Panneaux écrans) – FABRICS (Desktop screens) – STOFFEN (Privacy-panelen)

Bondai (100% polyester) – Cat A

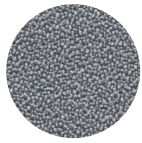

KD | Gris nuage
Cloud grey
Wolk grijs



KA | Gris orage
Storm grey
Storm grijs

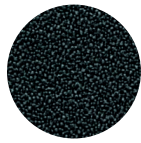

KE | Noir
Black
Zwart

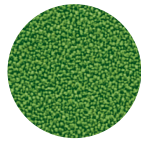

KF | Vert prairie
Prairie green
Weide groen

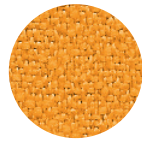

K4 | Jaune
Yellow
Geel

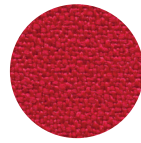

KZ | Rouge
Red
Rood

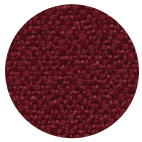

K6 | Bordeaux royal
Royal bordeaux
Bordeauxrood

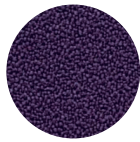

KG | Aubergine
Aubergine
Aubergine

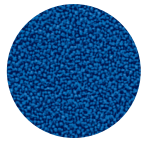

KC | Bleu électrique
Electric blue
Electra blauw

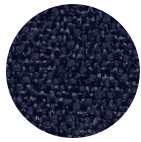

K2 | Bleu marine
Navy blue
Marine blauw

Xtreme CS (100% polyester) – Cat B

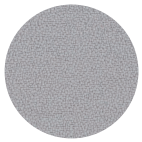

U4 | Gris clair
Light grey
Lichtgrijs

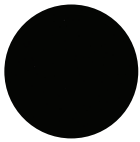

U5 | Noir
Black
Zwart

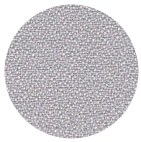

W3 | Gris beige
Beige grey
Beige grijs



W4 | Brun
Brown
Bruin

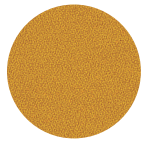

V6 | Jaune safran
Yellow
Saffraan

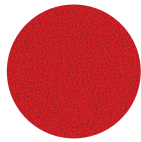

U1 | Rouge vermillon
Vermillion red
Vermiljoen



V8 | Vert printemps
Spring green
Lente groen

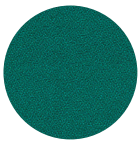

W1 | Vert canard
Duck green
Vedergroen

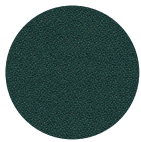

W2 | Vert impérial
Imperial green
Keizergroen

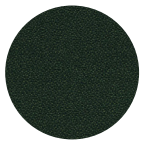

W5 | Vert brun
Green brown
Bruingrijs

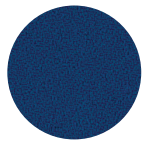

V1 | Bleu égyptien
Egyptian blue
Egyptisch blauw



W6 | Bleu nuit
Night blue
Nachtblauw

Step (100% Trevira CS) – Cat B

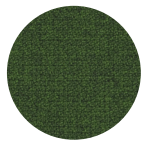

A1 | Bambou
Bamboo
Bamboe

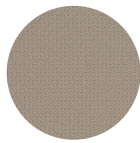

A2 | Beige
Beige
Beige

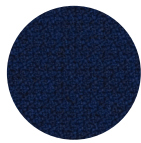

A3 | Bleu marine
Navy blue
Marine blauw

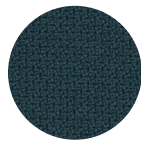

A4 | Bleu pétrole
Petroleum blue
Petroleum blauw

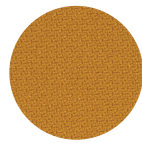

A5 | Jaune moutarde
Mustard yellow
Mosterd geel



A6 | Noir
Black
Zwart

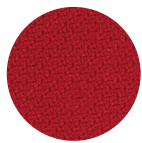

A7 | Rouge cardinal
Cardinal red
Kardinaal rood

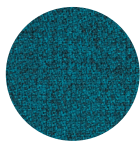

A8 | Turquoise
Turquoise
Turquoise

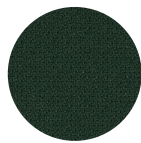

A9 | Vert anglais
English green
Engels groen

Step mélange (100% Trevira CS) - Cat B

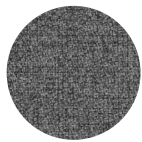

B1 | Anthracite chiné
Mottled graphite grey
Gespikkeld antraciet

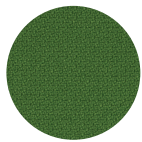

B2 | Bambou chiné
Mottled bamboo
Gespikkeld bamboe

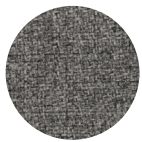

B3 | Beige chiné
Mottled beige
Gespikkeld beige

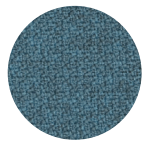

B4 | Bleu denim chiné
Mottled denim blue
Gespikkeld denim blauw

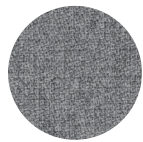

B5 | Gris clair chiné
Mottled light grey
Gespikkeld lichtgrijs

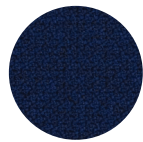

B6 | Marine chiné
Mottled navy blue
Gespikkeld marineblauw



B7 | Marron foncé chiné
Mottled dark brown
Gespikkeld donkerbruin

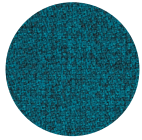

B8 | Turquoise chiné
Mottled turquoise
Gespikkeld turquoise



B9 | Violette chiné
Mottled dark purple
Gespikkeld violette

Blazer (100% laine vierge - virgin wool - scheerwol) - Cat D

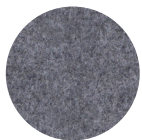

H6 | Gris moyen chiné
Mottled medium grey
Gespikkeld medium grijs



J8 | Gris foncé chiné
Dark mottled grey
Tweekleurig donkergrijs



HX | Jaune d'or
Gold
Goud



J2 | Marron foncé chiné
Mottled dark brown
Gespikkeld donkerbruin

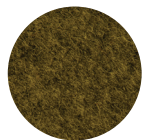

HA | Vert olive chiné
Mottled olive green
Gespikkeld olijfgroen



J9 | Vert impérial
Imperial green
Imperiaal groen

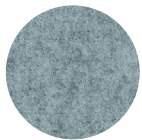

H9 | Bleu pâle chiné
Mottled pale blue
Gespikkeld pale blauw



HQ | Bleu céleste
Celestial blue
Hemel blauw



J6 | Rouge Wellington
Wellington red
Wellington rood



JG | Rose Marsala
Marsala pink
Marsala roze



I3 | Bordeaux
Bordeaux
Bordeauxrood

5. MÉTAL (pincés de fixation) - METAL (fixing clamps) - METAAL (bevestigingsklemmen)



SO | Blanc
White
Wit

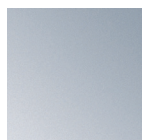

SA | Gris aluminium
Aluminium grey
Alugrijs



SG | Noir
Black
Zwart

SHOWROOMS

| PARIS

171, Avenue des Grésillons - 92230 Gennevilliers
Tel : +33 (0)1 47 33 47 37

| LONDON

4th Floor - 14-18 Old Street - London EC1V 9BH UK
Tel : +44 (0)203 794 66 07

| BRUXELLES

81, Chaussée de Nivelles - 1420 Braine-l'Alleud
Tel : +32 (0)2 894 99 80