

ROBIN



Signature
— BY EOL —



TENDANCE & FONCTIONNEL

ROBIN est une gamme de bureaux et de tables de réunion qui se distingue par l'assemblage subtil du bois massif et du métal, inscrivant son design dans la tendance actuelle de l'habitat. Afin de répondre à de multiples solutions d'aménagements, ROBIN se décline en plusieurs dimensions et formats. Avec ROBIN, réinventez vos espaces de travail pour qu'ils deviennent des lieux de bien-être, harmonieux et chaleureux, signant ainsi le retour à la nature.

TRENDY & FUNCTIONAL

ROBIN is a range of desks and meeting tables distinguished by the discreet assembly of solid wood and metal, inscribing its design into the current trend of living spaces. To provide various organisational solutions, ROBIN is available in several different sizes and formats. Use ROBIN to re-invent your working spaces so that they become places of well-being, harmonious and warm, thus signalling a return to nature.

TRENDY & FUNCTIONEEL

ROBIN is een collectie van bureaus en vergadertafels die opvalt door het subtiel samengaan van massief hout en metaal, waarmee ze perfect aansluit bij de hedendaagse tendens van het habitatgevoel op het werk. ROBIN biedt met zijn verschillende afmetingen en formaten altijd een oplossing om van uw kantooromgeving een uitnodigende, harmonieuze en warme plek te maken.

UN DESIGN INSPIRÉ DE L'HABITAT
A DESIGN INSPIRED BY LIVING SPACES
DESIGN MET HET HABITATGEVOEL ALS INSPIRATIEBRON



Fabriqué dans nos usines françaises, ROBIN garantit une gamme aux finitions soignées et de qualité. Moderne avec un design exclusif, ROBIN associe douceur et robustesse. S'inspirant des codes formels de l'habitat, son pied en bois massif aux lignes arrondies associé au métal proposent des détails subtils et harmonieux.

Made in our French factories, ROBIN guarantees a carefully-devised, high quality range of finishes. Modern with an exclusive design, ROBIN combines softness with robustness. Inspiring the formality of these living spaces, its solid wooden legs with rounded lines connected to the metal propose subtle and harmonious details.

ROBIN wordt vervaardigd in onze fabrieken in Frankrijk en staat borg voor onberispelijke afwerking en kwaliteit. Het moderne en exclusieve design van ROBIN combineert zachte lijnen en stevigheid. De habitatsfeer vormt de inspiratiebron en de massiefhouten poten met afgeronde lijnen in combinatie met metaal zorgen voor subtiele en harmonieuze details.



Pied en hêtre massif aux lignes fuselées et arrondies
Solid beech legs with spindle shaped, rounded lines.
Poot van massief beuken met conische en afgeronde lijnen



Association subtile du bois et du métal
Subtile connection of wood and metal
Subtiel samengaan van hout en metaal

TRAVAILLER SEUL OU EN POSTE PARTAGÉ
WORKING INDEPENDENTLY OR IN A SHARED WORKSPACE
WERKEN AAN EEN INDIVIDUEEL OF GEDEELD BUREAU



Aménager vos espaces de travail selon vos besoins : en bureaux bench pour favoriser la communication et les échanges ou en bureaux individuels pour privilégier la concentration de vos collaborateurs. Les bureaux individuels se déclinent également en version manager.

Organise your workspaces according to your needs: in benches to favour communication and exchanges or on individual desks to make it easier for your colleagues to concentrate. Individual desks are also available in a manager version.

Uw werkomgeving inrichten volgens uw eigen noden: met bench bureaus die communicatie en samenwerking bevorderen of met individuele bureaus waaraan uw medewerkers zich maximaal kunnen concentreren. De individuele bureaus zijn ook leverbaar in managerversie.



Avec ROBIN version manager, recevez vos collaborateurs ou visiteurs en toute sérénité avec une ergonomie bien pensée : l'électrification est située sur le côté du bureau pour favoriser le confort d'utilisation et la communication. Aussi, son rangement de proximité de faible encombrement permet au manager de ranger ses documents et effets personnels grâce à la porte sécurisée.

With the manager version ROBIN, your colleagues or visitors will have complete peace of mind with well-conceived ergonomics: cable guides are located on the side of the desk to make it easier to use and communicate. Also, its low footprint storage easy-to-reach spaces allow the manager to store their documents and personal items thanks to the secure door.

Met ROBIN in managerversie ontvangt u uw medewerkers of bezoekers in alle sereniteit én een doordachte ergonomie: kabelgeleiding aan de zijkant van het bureau voor maximaal gebruikscomfort en open communicatie. In het plaatsbesparende opbergmeubilair binnen handbereik kunt u persoonlijke documenten en bezittingen veilig opbergen dankzij de vergrendelbare deur.

SE RÉUNIR MEET UP VERGADEREN



Grâce à ses grandes capacités d'accueil, ROBIN permet de se réunir autour d'une table chaleureuse et fonctionnelle privilégiant ainsi les échanges entre collaborateurs. Ses pieds spécifiques sur platine permettent un confort optimal pour les utilisateurs. Ils sont positionnés en extrémité et au centre en version postes départ/suivant avec un ou plusieurs pieds partagés rentrants. En table haute, son repose pied offre un style graphique tout en favorisant l'ergonomie de l'ensemble.

Thanks to its large, accommodating capacities, ROBIN allows meeting around a pleasant, functional table that also encourages exchanges between colleagues. Its specific legs on the worktop allow optimum comfort for its users. They are positioned at the end and in the centre in the start/finish station version with one or more inset split legs. In the high table version, its resting leg provides a graphic style making the whole more ergonomic.

ROBIN valt op met zijn ruime afmetingen, wat medewerkers de mogelijkheid biedt om samen te komen en vooral samen te werken rond een uitnodigende en functionele tafel. De specifieke poten met bevestigingsplaat staan borg voor maximaal gebruikerscomfort. Zij zijn geplaatst aan het uiteinde en in het midden in de versie start/finishstation met één of meer ingezette gedeelde poten. In de hoge versie zorgt de voetensteun voor een grafische stijl en een perfecte ergonomie van het geheel.

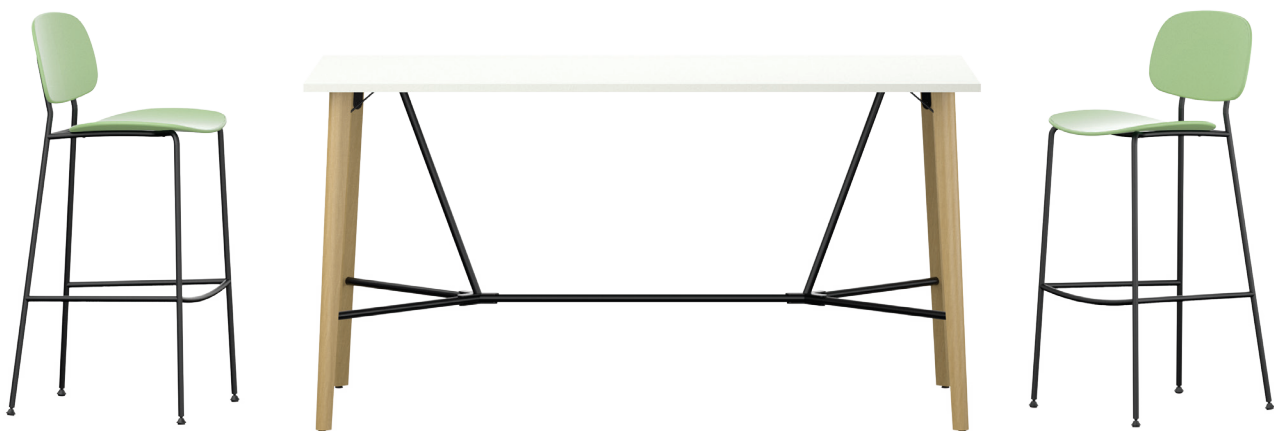

Optez pour des tables rondes, carrées ou rectangulaires, disponibles en différents formats et hauteurs, pour vos réunions informelles ou brainstorming, en plus petit comité.

Choose round, square or rectangular tables, available in various formats and heights, for your informal meetings or brainstorming, in the smallest groups.

U kunt kiezen voor ronde, vierkante of rechthoekige tafels, leverbaar in verschillende formaten en hoogtes. Ideaal voor informele vergaderingen of brainstorming met een beperkt aantal deelnemers.



PERSONNALISER ROBIN
CONFIGURE ROBIN
ROBIN PERSONALISEREN



Les multiples versions et formats de ROBIN permettent de répondre aux différents besoins d'aménagement des utilisateurs. En complément, vous pouvez personnaliser votre bureau bench en ajoutant un rangement de proximité JAMES, tout en harmonie. Côté accessoires, le voile de fond textile et les panneaux écrans acoustiques SOLANGE apporteront chaleur et confort à votre espace de travail.

Multiple versions and formats of ROBIN allows it to meet the various organisational needs of its users. In addition, you can customise your bench by adding a JAMES easy-to-reach storage unit, completely harmoniously. These accessories, the fabric-backed modesty panel and SOLANGE acoustic desktop screens bring warmth and comfort to your workspace.

Met de talrijke versies en formaten biedt ROBIN altijd het perfecte antwoord voor de inrichting van uw werkomgeving. Aanvullend kunt u uw bench bureau in perfecte harmonie personaliseren met opbergmeubilair JAMES. Met accessoires als het stoffen frontpaneel of de geluiddempende privacy-panels SOLANGE voegt u warmte en comfort toe.

Options
Options
Opties



Possibilité d'ajouter un tiroir pour D.S. dans la niche du rangement de proximité
Possibility of adding an S.F. draw in the easy-to-reach storage niche
Mogelijkheid om een hangmappenlade toe te voegen in het opbergvak

Configurations du bureau manager
Manager desk configurations
Configuraties van het managerbureau



Rangement de proximité aligné ou débordant du plateau avec passe câbles intégré dans le meuble
Easy-to-reach storage that is aligned with or overshooting the worktop with cable trough integrated into the unit
Opbergmeubilair in lijn of uitspringend ten opzichte van het bureaublad, kabeldoorgang in het meubel

Suggestions de personnalisation
Suggested configurations
Mogelijkheden tot personaliseren



Rangement de proximité JAMES® pour les bureaux bench
Easy-reach JAMES® storage for benches
JAMES® opbergmeubilair voor bench bureaus



Panneaux écrans acoustiques SOLANGE®
SOLANGE® acoustic desktop screens
Geluiddempende privacy-panels SOLANGE®



Voile de fond textile
Modesty panel
Stoffen frontpaneel



SYNTHÈSE & DIMENSIONS

—

SUMMARY & DIMENSIONS

OVERZICHT & AFMETINGEN

GAMME RANGE COLLECTIE

Bureaux individuels - Individual desks - Individuele bureaus



Rectangulaires
Rectangular
Rechthoekig

Bureaux structure partagée - Benches - Bench bureaus



Double plateaux rectangulaires
Double rectangular worktops
Dubbel rechthoekig blad



Mono plateaux grande profondeur
Single deep worktops
Extra diep enkel blad



Bureaux Bench départ / suivant avec pied intermédiaire rentrant
Starter / add-on desks with retractable middle leg
Bench bureaus basis / aanbouw met inspringende tussenpoot

Bureaux manager avec ou sans rangement de proximité – Manager desks with or without easy-to-reach storage – Managerbureau met of zonder opbergmeubel



Rectangulaires Prof 1000 mm
Rectangular 1000 mm deep
Rechthoekig Diepte 1000 mm



Bureaux avec meuble bas structurel* aligné ou débordant du plateau
Desks with low structural unit* aligned with or overshooting the worktop
Bureaus met structureel laag meubel*, in lijn of uitspringend ten opzichte van het blad

Retours et extensions – Returns and extensions – Aanbouwtafels en aanbouwbladen



Retour rectangulaire sur piètement arche
Rectangular return on bridge legs
Rechthoekige aanbouwtafel op portaalpoot



Plan demi-lune pour bureaux individuels
Half-moon worktop for individual desks
Halfmond aanbouwblad voor individuele bureaus



Plans demi-lune pour bureaux bench
Half-moon worktops for benches
Halfmond aanbouwblad voor bench bureaus

* Se positionne à droite ou à gauche du plan de travail - * To be positioned to the right or left of the worktop - * Te plaatsen aan de rechter of linkerkant van het werkblad

Tables de réunion H. 735mm - H. 735 mm meeting tables - Vergadertafels H. 735 mm



Carrés
Square
Vierkant



Rectangulaires
Rectangular
Rechthoekig



Rondes
Round
Rond



Tables Prof. 1200 mm grande capacité
High capacity 1200 mm deep tables
Extra grote tafels, diepte 1200 mm

Tables hautes de réunion H. 1045 mm - H. 1045 mm high meeting tables - Hoge vergadertafels H. 1045 mm



Carrés
Square
Vierkant



Rectangulaires
Rectangular
Rechthoekig



Rondes
Round
Rond



Tables Prof. 1200 mm grande capacité
High capacity 1200 mm deep tables
Extra grote tafels, diepte 1200 mm

SYNOPTIQUE SYNOPTIC OVERZICHT

Bureaux individuels - Individual desks - Individuele bureaus

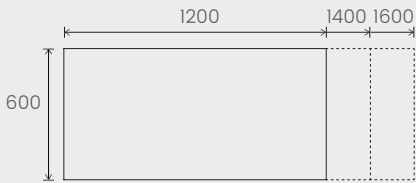
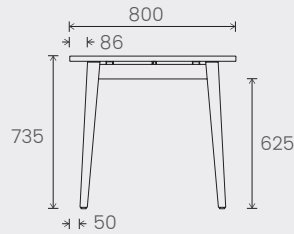
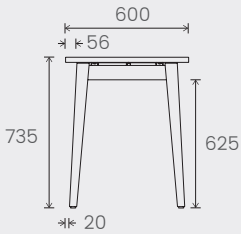

Connectique
Cable management
Connectiek

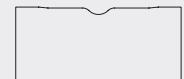

Bureaux structure partagée - Desks with shared structural fram - Bureaus met gedeeld onderstel

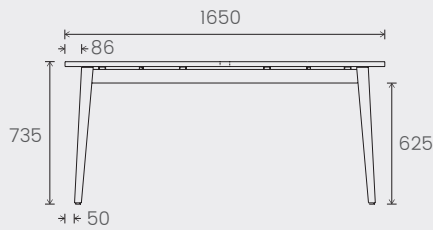
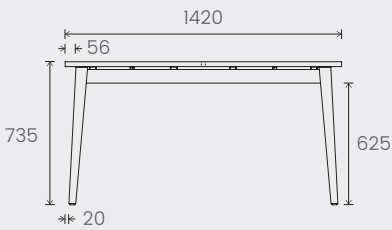

Mono plateaux - Shared single worktop - Enkel blad basis

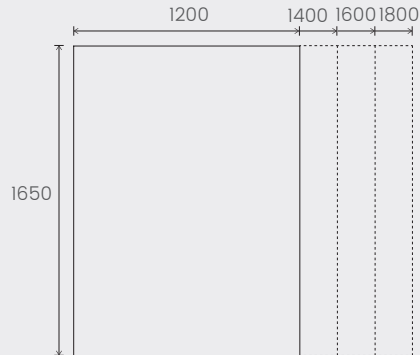
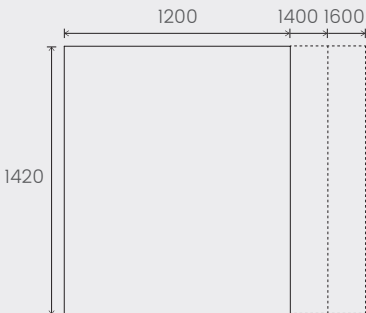

Connectique
Cable management
Connectiek

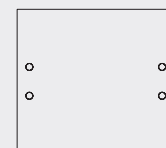

2 plateaux rectangulaires - 2 rectangular worktop - 2 rechthoekige bladen

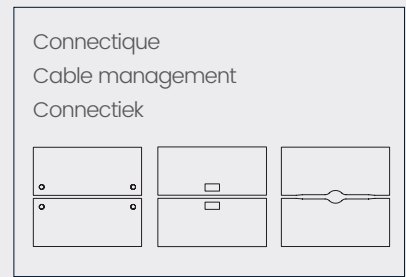
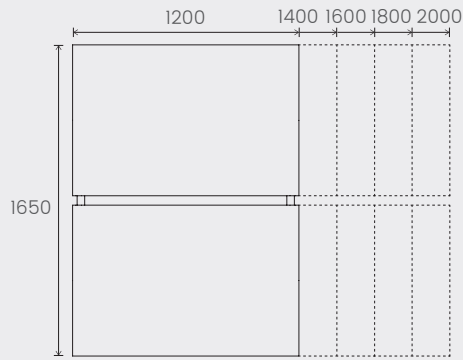
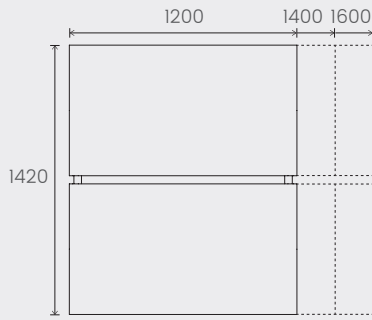

Bureaux manager avec ou sans rangement de proximité - Manager desks with or without easy-to-reach storage - Managerbureau met of zonder opbergmeubel

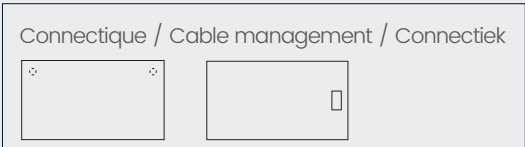
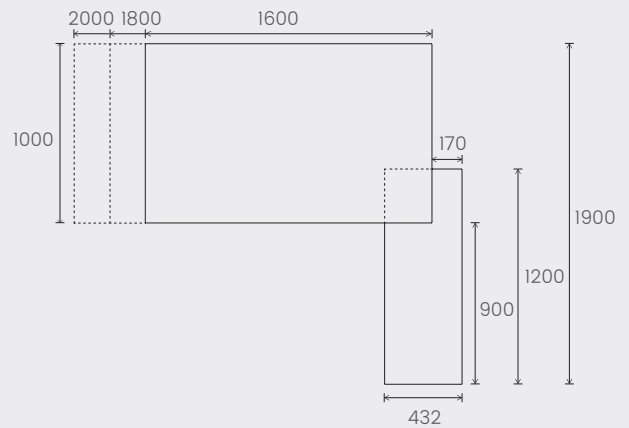
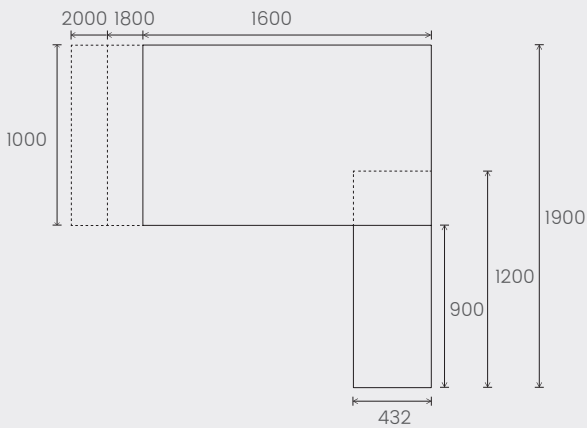
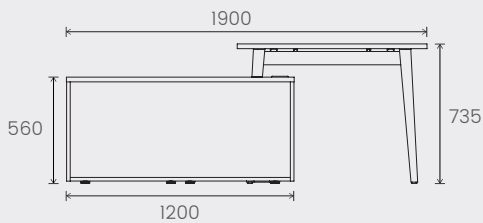
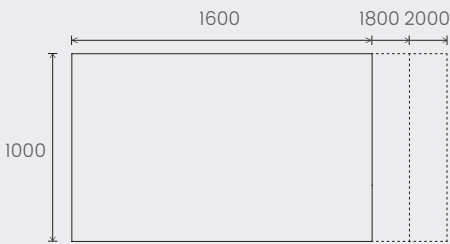
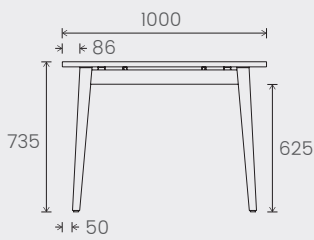

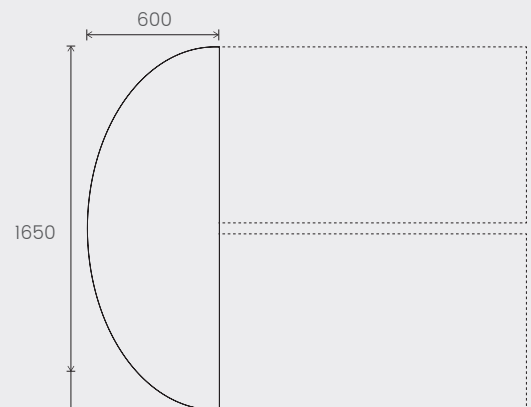
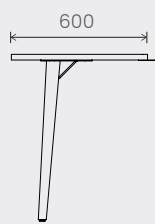
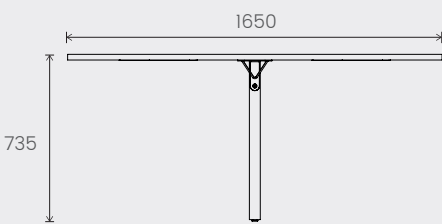
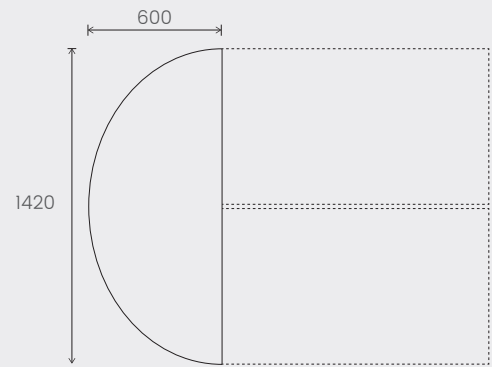
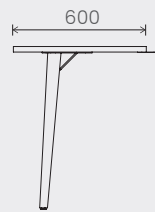
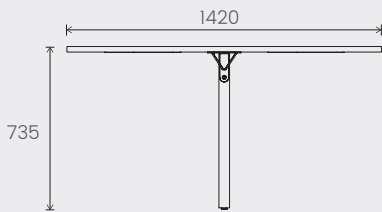
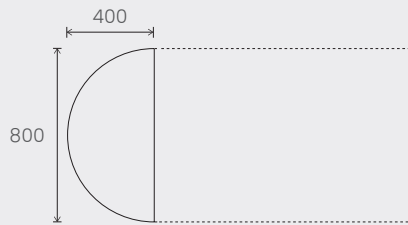
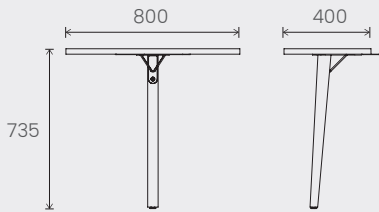
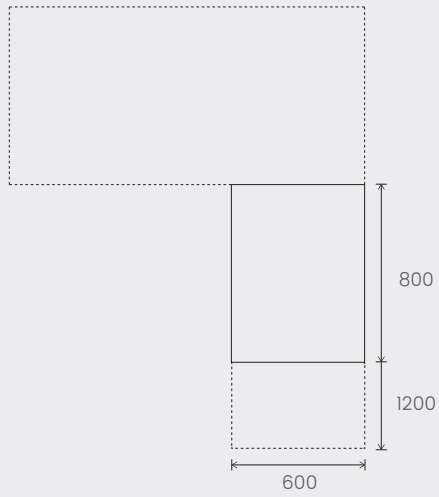
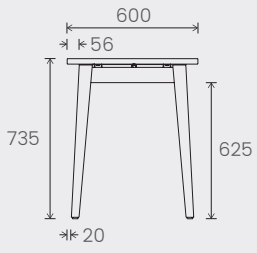

Tables de réunion H. 735mm - H. 735 mm meeting tables - Vergadertafels H. 735 mm

Profondeur 800 mm - D.800mm - D.800mm

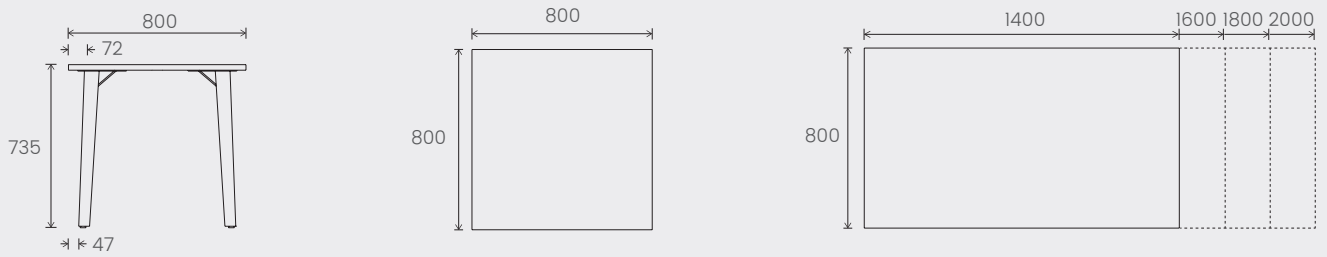

Profondeur 1000 mm - D.1000mm - D.1000mm

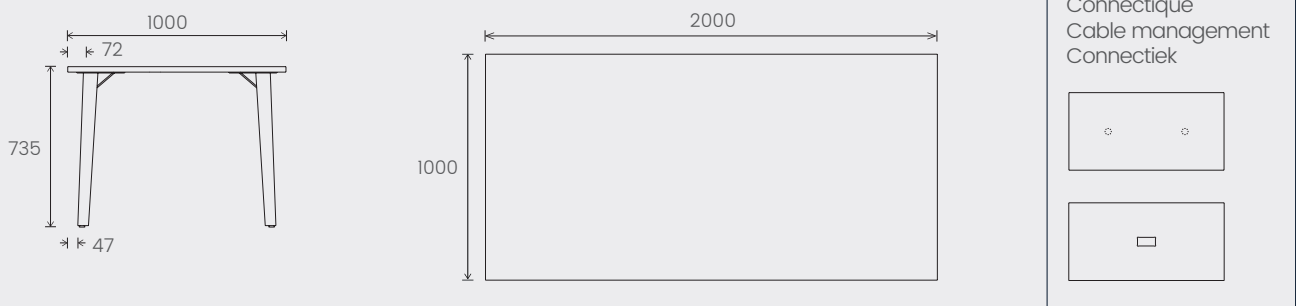

Profondeur 1200 mm - D.1200mm - D.1200mm

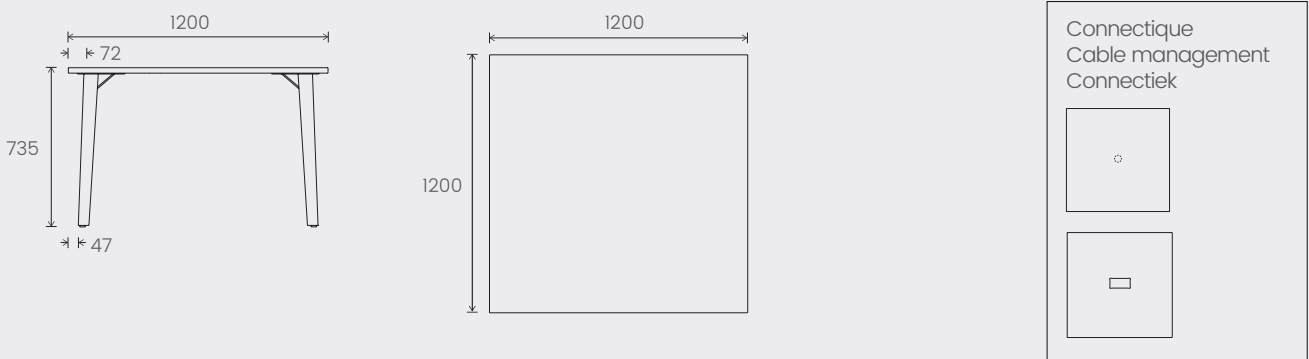

Ronde - Circular - Ronde

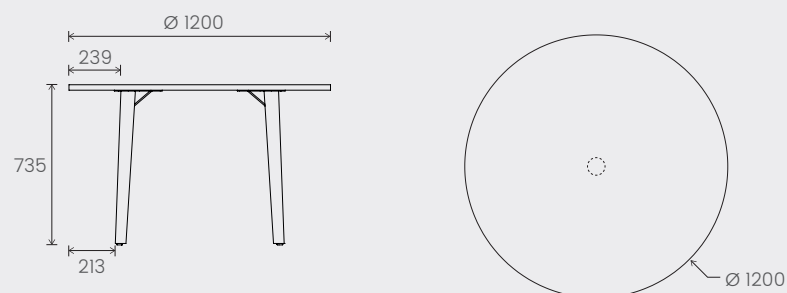

Profondeur 1200 mm à juxtaposer - Apposable D.1200mm - D.1200mm te stellen

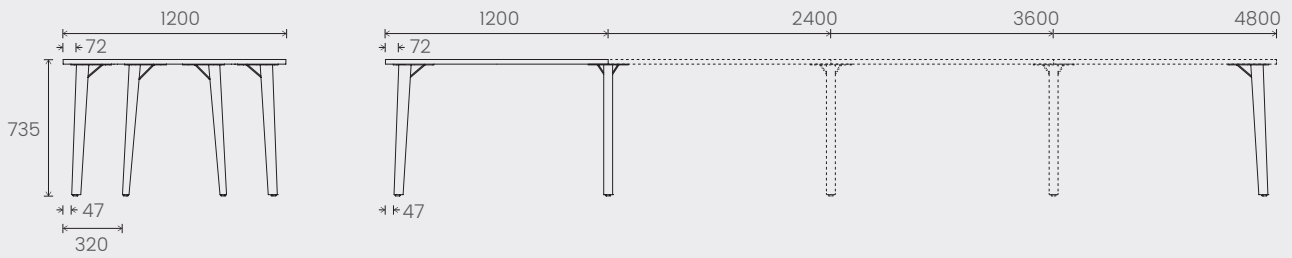

8 personnes - 8 people - 8 personen

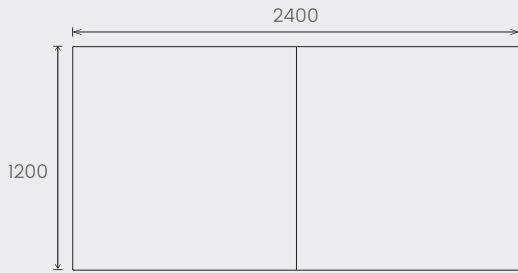

12 personnes - 12 people - 12 personen

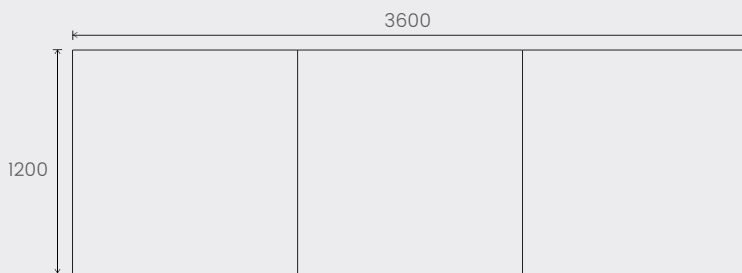

16 personnes - 16 people - 16 personen

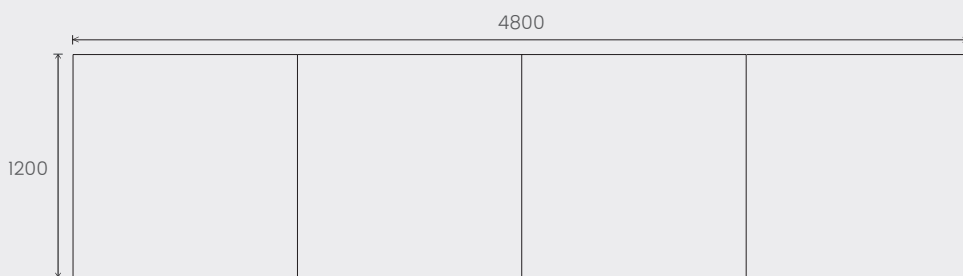

Connectique* / Cable management* / Connectiek*



* Le choix de la connectique s'applique à l'ensemble des plateaux de la configuration
 * The choice of connectors applies to all worktops in the configuration
 * De keuze van de connectoren geldt voor alle bladen in de configuratie

Tables hautes de réunion H. 1045 mm - H. 1045 mm meeting tables - Hoge vergadertafels H. 1045 mm

Profondeur 800 mm - D.800mm - D.800mm

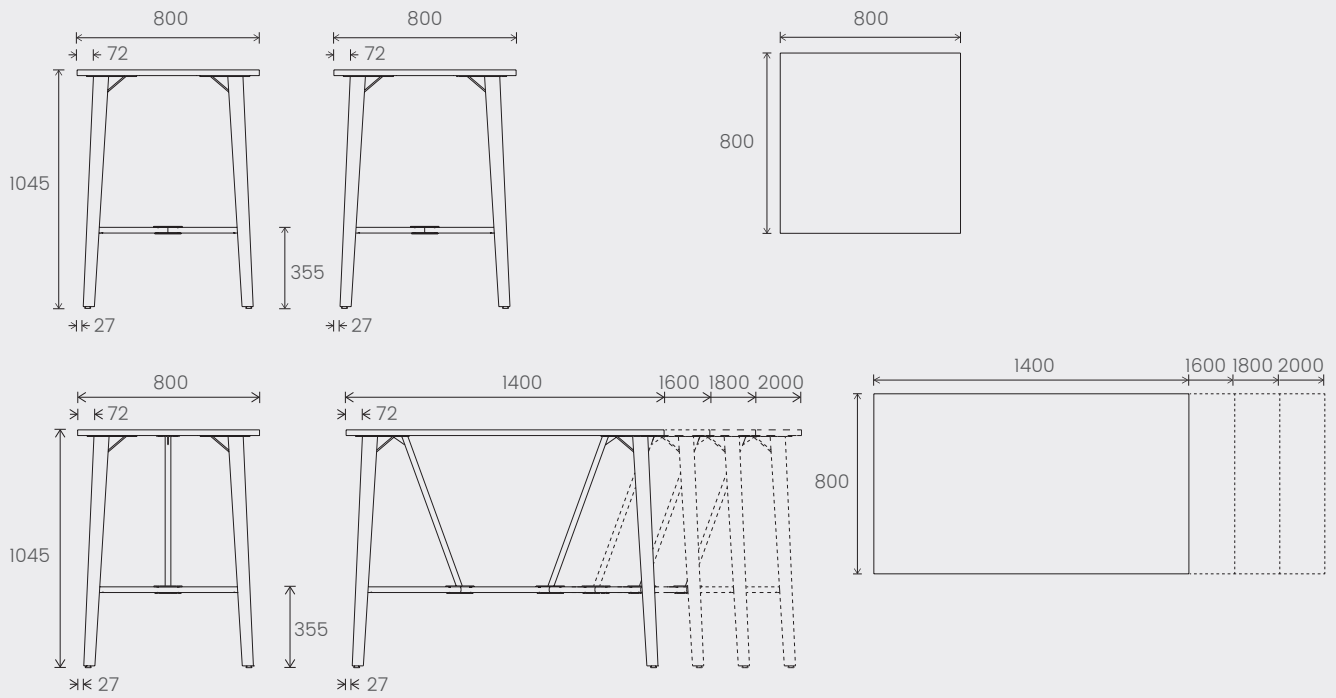

Profondeur 1000 mm - D.1000mm - D.1000mm

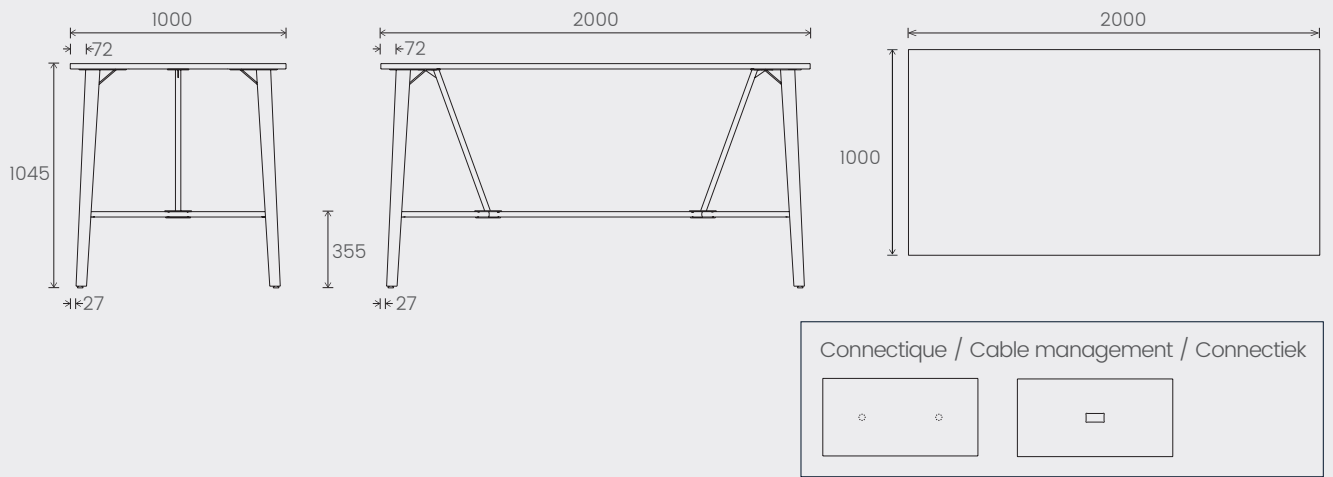

Profondeur 1200 mm - D.1200mm - D.1200mm

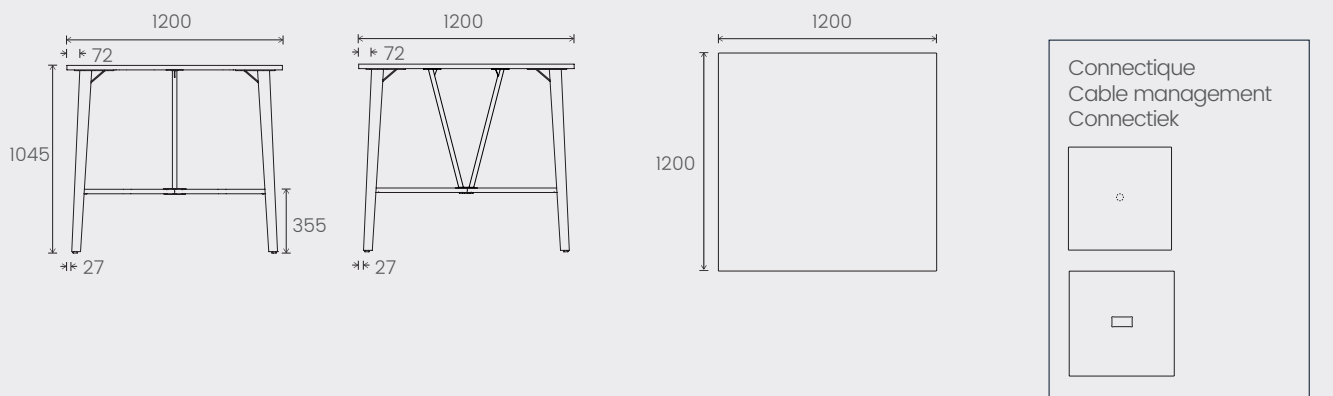

Ronde - Circular - Ronde

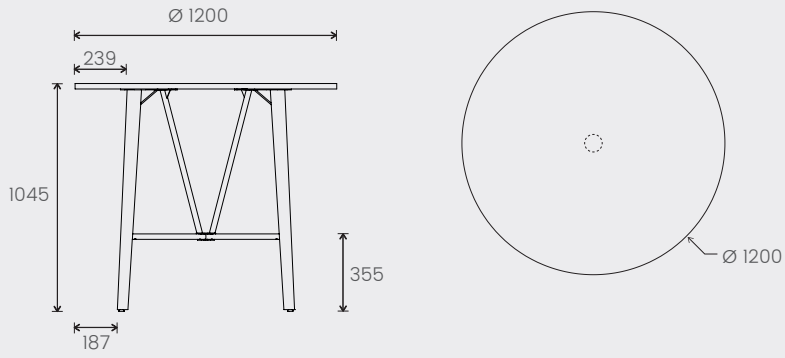

Profondeur 1200 mm à juxtaposer - Apposable D.1200mm - D.1200mm te stellen

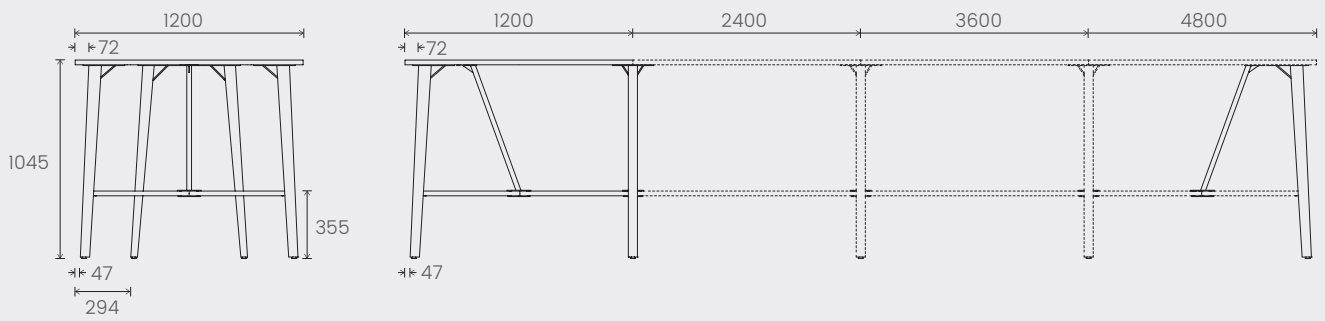

8 personnes - 8 people - 8 personen

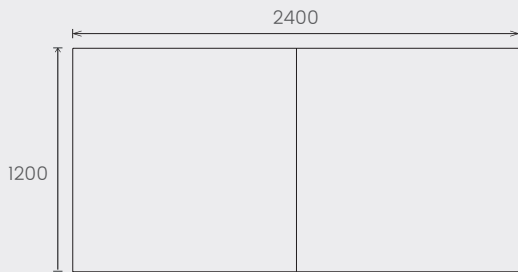

12 personnes - 12 people - 12 personen

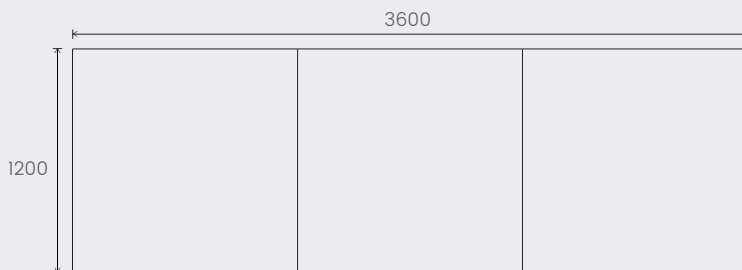

16 personnes - 16 people - 16 personen

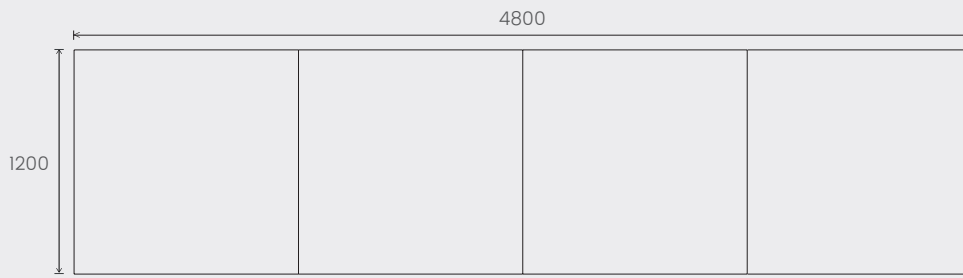

Connectique* / Cable management* / Connectiek*



- * Le choix de la connectique s'applique à l'ensemble des plateaux de la configuration
- * The choice of connectors applies to all worktops in the configuration
- * De keuze van de connectoren geldt voor alle bladen in de configuratie



MATIÈRES & COULEURS

—

MATERIALS & COLOURS

MATERIALEN & KLEUREN

Bureaux et Tables de réunions – desks and meeting tables – bureaus en vergadertafels

1. MELAMINE (Plateaux) – MELAMINE (Worktops) – MELAMINE (Bladen)

STOCK ⁽¹⁾		DÉLAI ⁽²⁾		

+5%

*Tables de réunion disponibles en stock uniquement en coloris MG, autres coloris sur délais – *Meeting tables available in stock only in colour MG, other colours on request – *Vergadertafels alleen in kleur MG uit voorraad leverbaar, andere kleuren op aanvraag

2. MÉTAL/BOIS (piètement) – METAL/WOOD (LEGS) – METAAL/HOUT (poten)

STOCK ⁽¹⁾	DÉLAI ⁽²⁾

					DÉLAI ⁽²⁾

+5%

* MS Hêtre naturel / Natural beech / Naturel beuken

S Exclusivité / Exclusive to / Exclusiviteit
SIGNATURE BY EOL

+5%



majoration de 5% sur le PP HT indiqué
5% mark-up on the RRP excl. tax
meerprijs van 5% op de opgegeven verkoopprijs excl. BTW

⁽¹⁾ STOCK SELON RÉFÉRENCES
STOCK DEPENDING ON REFERENCES
VOORRAAD AFHANKELIJK VAN REFERENTIES

⁽²⁾ DÉLAI 6 SEMAINES
ON REQUEST 6 WEEKS
MET LEVERTIJD 6 WEKEN





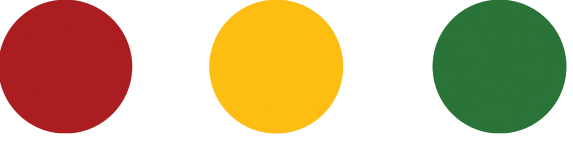



Bureaux manager avec rangement de proximité – Manager desks with easy-reach storage – Managerbureau met opbergmeubel

1. MELAMINE (plateau et corps du rangement de proximité, façade du tiroir DS) – MELAMINE (worktop and panel of the easy-reach storage, front of the SF drawer) – MELAMINE (werkblad, paneel van de easy-reach berging, voorkant van de SF lade)

 <p>MG Blanc neige Snow white Sneeuw wit</p> <p>RI Chêne clair Light oak Licht eiken</p> <p>STOCK ⁽¹⁾</p>		 <p>M6 Gris cachemire Cashmere grey Kasjmier grijs</p> <p>M7 Vert fjord Fjord green Fjord groen</p> <p>DÉLAI ⁽²⁾</p>		 <p>M5 Gris brume Mist grey Nevel grijs</p> <p>M2 Vert fougère* Fern green* Varen groen*</p> <p>DÉLAI ⁽²⁾</p>		<p>+5%</p> <ul style="list-style-type: none"> ⚠ Porte coulissante du rangement de proximité assortie au plateau du bureau ⚠ Proximity storage sliding door to match the desk top ⚠ Opbergruimte met schuifdeur, passend bij het bureaublad
 <p>M1 Rouge cerise* Cherry red* Kers rood*</p> <p>M4 Jaune tournesol* Sunflower yellow* Zonnebloem geel*</p> <p>M2 Vert fougère* Fern green* Varen groen*</p> <p>DÉLAI ⁽²⁾</p>						

*Coloris M1, M4 et M2 uniquement pour la façade du tiroir DS tiroir vendu en option – *Colour M1, M4 and M2 only for the front of the SF drawer sold as an option – *Kleur M1, M4 en M2 alleen voor de voorzijde van de SF-lade, verkocht als optie

2. MÉTAL/BOIS (Piètement) – METAL/WOOD (legs) – METAAL/HOUT (poten)

 <p>SO MS* Blanc White Wit</p> <p>STOCK ⁽¹⁾</p>		 <p>SG MS* Noir Black Zwart</p> <p>DÉLAI ⁽²⁾</p>		<ul style="list-style-type: none"> ⚠ Poignée profil métal de la porte assortie au piètement ⚠ Metal handle of the storage door matched to the legs ⚠ Metalen handgreep van de opbergdeur passend bij de poten 	
 <p>X6 MS* Rouge carmin Carmine red Karmijn rood</p>		 <p>X5 MS* Jaune tournesol Sunflower yellow Zonnebloem geel</p>		 <p>X3 MS* Vert émeraude Emerald green Smaragd groen</p>	
 <p>X2 MS* Turquoise pastel Pastel turquoise Pastel turquoise</p>		 <p>X8 MS* Vert pâle Pale green Bleek groen</p>		 <p>X2 MS* Gris platine Platinum grey Platina grijs</p>	

⁽¹⁾ STOCK SELON RÉFÉRENCES
STOCK DEPENDING ON REFERENCES
VOORRAAD AFHANKELIJK VAN REFERENTIES

⁽²⁾ DÉLAI 6 SEMAINES
ON REQUEST 6 WEEKS
MET LEVERTIJD 6 WEKEN

S Exclusivité / Exclusive to / Exclusiviteit
SIGNATURE BY EOL

+5% majoration de 5% sur le PP HT indiqué
5% mark-up on the RRP excl. tax
meerprijs van 5% op de opgegeven verkoopprijs excl. BTW

SHOWROOMS

| PARIS

1 rue des Céréales – Bât 112
93200 SAINT DENIS
Tel : +33 (0)1 49 35 60 00

| NIEUWEGEIN

Symfonielaan 1 3438 EW Nieuwegein, Nederland
Tel : +31 (0) 6 823 62 118

| BRUXELLES

81, Chaussée de Nivelles – 1420 Braine-l'Alleud
Tel : +32 (0)2 894 99 80