

# SOLANGE



**Signature**  
— BY EOL —



## ASTUCIEUSE & ACOUSTIQUE

**L**es panneaux écrans et cloisons SOLANGE permettent de configurer un espace partagé en espaces privés propices à la concentration. Grâce à leur haut niveau d'absorption sonore, les panneaux écrans et cloisons réduisent de manière importante les nuisances du quotidien, tout en apportant une esthétique harmonieuse. Caractérisées par des lignes arrondies, les cloisons acoustiques SOLANGE se combinent entre elles grâce à un astucieux système de liaison développé par notre StudioDesign.

---

## CLEVER & SOUNDPROOFING

**S**OLANGE desktop screens and partitions allow for the creation of private areas within a larger shared workspace, favouring concentration. Thanks to their highly effective sound absorption qualities, these acoustic screens and partitions significantly reduce the disruptive impact of ambient noise, whilst at the same time providing an aesthetically harmonious backdrop to the workspace. Specially designed by our StudioDesign, SOLANGE partition screens can be effortlessly combined thanks to a shared aesthetic and a clever linking system using connector knobs.

---

## VERNUFTIG & GELUIDDEMPEND

**M**et de privacy-panels en scheidingswanden SOLANGE kan een open ruimte opgedeeld worden in persoonlijke en concentratie bevorderende werkplekken. Dankzij hun hoog geluiddempend vermogen bieden deze privacy-panels en scheidingswanden een efficiënte én elegante oplossing voor geluidshinder in de werkomgeving. De geluiddempende panelen SOLANGE met hun afgeronde vormen kunnen onderling gecombineerd worden dankzij een vernuftig systeem dat werd ontwikkeld door onze eigen StudioDesign.

---

**STRUCTURER LES ESPACES**  
**PROVIDING STRUCTURE TO SPACES**  
**STRUCTUREREN VAN WERKRUIMTEN**



Seul ou à plusieurs, personnaliser  
son espace de travail  
Whether in single or grouped configuration,  
personalise your workspace  
De werkruiimte personaliseren,  
individueel of in cluster





Cloisons en lignes ou multidirectionnelles, reliées par des kits de liaison astucieux et esthétiques. Montage et démontage des cloisons sans outils.

Partitions arranged in linear or multi-directional configurations are linked using clever and aesthetically pleasing connector kits. Partitions are quick and easy to assemble or dismantle, without the need for tools.

Scheidingswanden in lijn of multidirectioneel dankzij een vernuftig en elegant koppelsysteem. Montage en demontage zonder gereedschap.

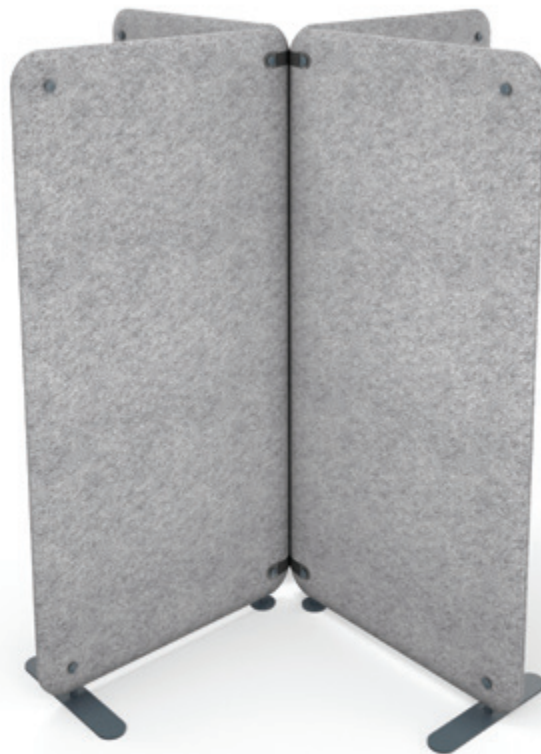

**CONFORT ACOUSTIQUE**  
**ACOUSTIC COMFORT**  
**AKOESTISCH COMFORT**

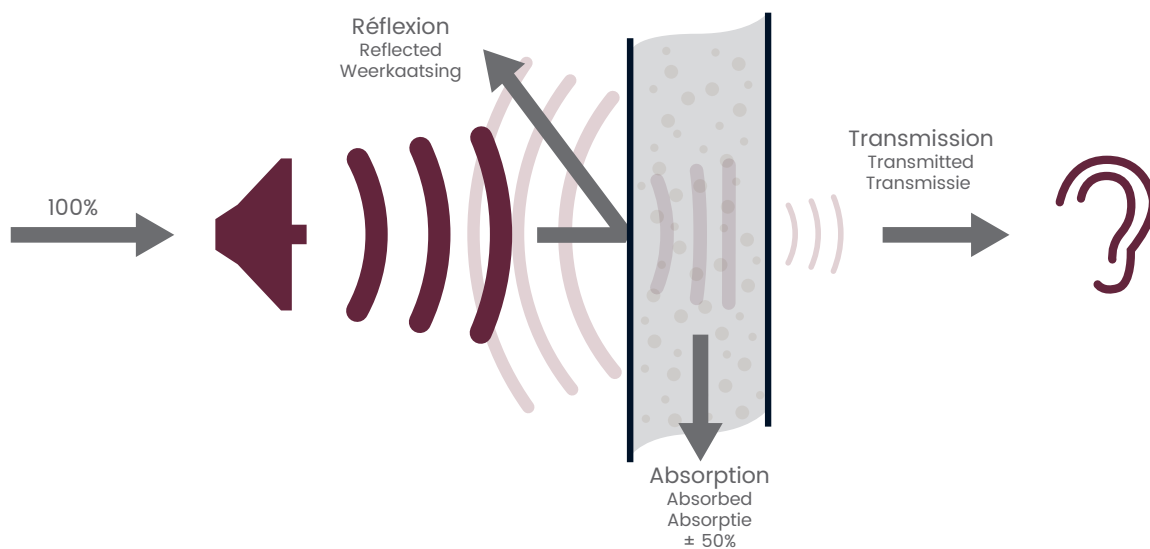

Les collaborateurs ont besoin d'espaces calmes pour travailler efficacement et sereinement. Plus de 60% des collaborateurs sont exposés à des nuisances sonores (sonneries de téléphone, discussions, serveurs, etc.) qui sont source de fatigue et de déconcentration. Grâce à ses propriétés acoustiques testées par le laboratoire CEDIA\*, SOLANGE est la solution idéale pour apporter un confort phonique optimisé dans un espace collaboratif.

Staff require peaceful environments in which to work effectively. Over 60% of employees are exposed to disruptive noise in the workplace (telephones ringing, conversations, noisy servers, etc.) which all contribute to loss of concentration and feelings of fatigue. SOLANGE is the perfect solution for collaborative spaces where optimal acoustic comfort is needed. It achieves this thanks to impressive acoustic soundproofing properties that have been thoroughly tested by CEDIA.\*

Uw medewerkers hebben nood aan een rustige plek om efficiënt en geconcentreerd te werken. Meer dan 60% van de kantoorwerkers wordt blootgesteld aan geluidshinder (rinkelende telefoons, gesprekken, servers, enz.) en dat leidt tot vermoeidheid en concentratieverlies. Dankzij de in het CEDIA geteste geluiddempende eigenschappen biedt SOLANGE de ideale oplossing om voor maximaal akoestisch comfort te zorgen in een gedeelde werkomgeving.

\*Centre d'Études et de Développement en Ingénierie Acoustique (Belgique)

\*Center for Research and Development in Acoustic Engineering (Belgium)

\*Centre d'Études et de Développement en Ingénierie Acoustique (Luik, België)

# +/- 50%

des nuisances sonores sont absorbées par les panneaux acoustiques SOLANGE

57%\* des personnes interrogées disent être souvent gênées par les nuisances sonores dues à des personnes et des appareils, ce qui place le bruit en première position des gênes ressenties (contre 34% en 2011 et 52% en 2013).

\*D'après le baromètre ACTINEO/CSA 2015

# +/- 50%

of nuisance ambient noise is effectively absorbed by SOLANGE acoustic partition screens

When surveyed, 57%\* of respondents say that they are often distracted by nuisance ambient noise caused by other people and equipment. This means that noise is perceived as being the principal source of disruption in the workplace (against 34% in 2011 and 52% in 2013).

\*Source: ACTINEO/ CSA 2015

# +/- 50%

van de geluidshinder wordt geabsorbeerd door de privacy-panels SOLANGE

57%\* van de ondervraagde personen geven aan hinder te ondervinden van het geluid van personen en apparaten. Daarmee staat geluid op de eerste plaats bij de bronnen van hinder (tegenover 34% in 2011 en 52% in 2013).

\* Volgens de barometer ACTINEO/CSA 2015

## Rapport de test acoustique réalisé sur les panneaux acoustiques SOLANGE Acoustic testing report for SOLANGE acoustic partition screens Akoestisch testverslag op de geluiddempende panelen SOLANGE

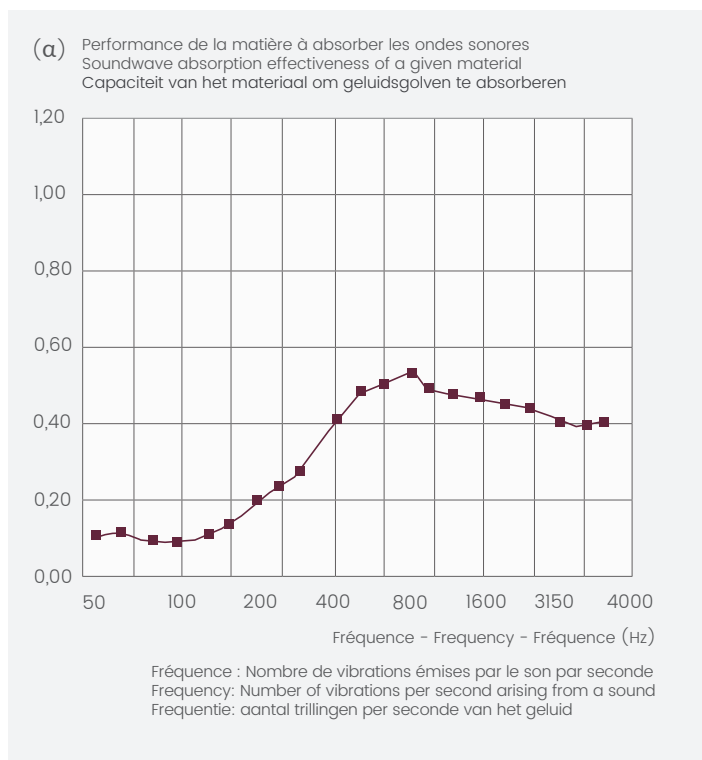

Les plages de fréquences des bruits dans un environnement de travail se situent entre 250 et 4000 Hertz.

The sound frequency range for sounds experienced in a working environment varies between 250 and 4,000 Hertz.

De frequenties van geluid in een werkomgeving situeren zich tussen de 250 en 4000 Hertz.

Hz	125	160	200	250	500	1000	2000	2500	3150	4000
α	0,13	0,16	0,21	0,27	0,52	0,51	0,47	0,45	0,42	0,40

### Caractéristiques techniques de SOLANGE - SOLANGE technical specifications - Technische kenmerken van SOLANGE

Structure périphérique en aluminium habillée de tissu. Ame en carton alvéolaire ép. 25 mm avec 1 couche de 10 mm de fibre polyester acoustique sur chaque face. Ep. 47 mm. Panneau punaisable.

Outer frame made from aluminium covered with fabric. Core made from honeycomb cardboard 25 mm thick, clad with 1 layer of 10 mm thick acoustic polyester fibre on each panel face. Thickness 47 mm. Tackable panel surface.

Aluminium frame overtrokken met stof. Kern van honingraatkarton, dikte 25 mm, met aan weerszijden een laag geluiddempende polyestervezel, dikte 10 mm. Dikte 47 mm. Bruikbaar als prikbord.

**PANNEAUX ÉCRANS ACOUSTIQUES**  
**ACOUSTIC DESKTOP SCREENS**  
**GELUIDDEMPENDE PRIVACY-PANELEN**

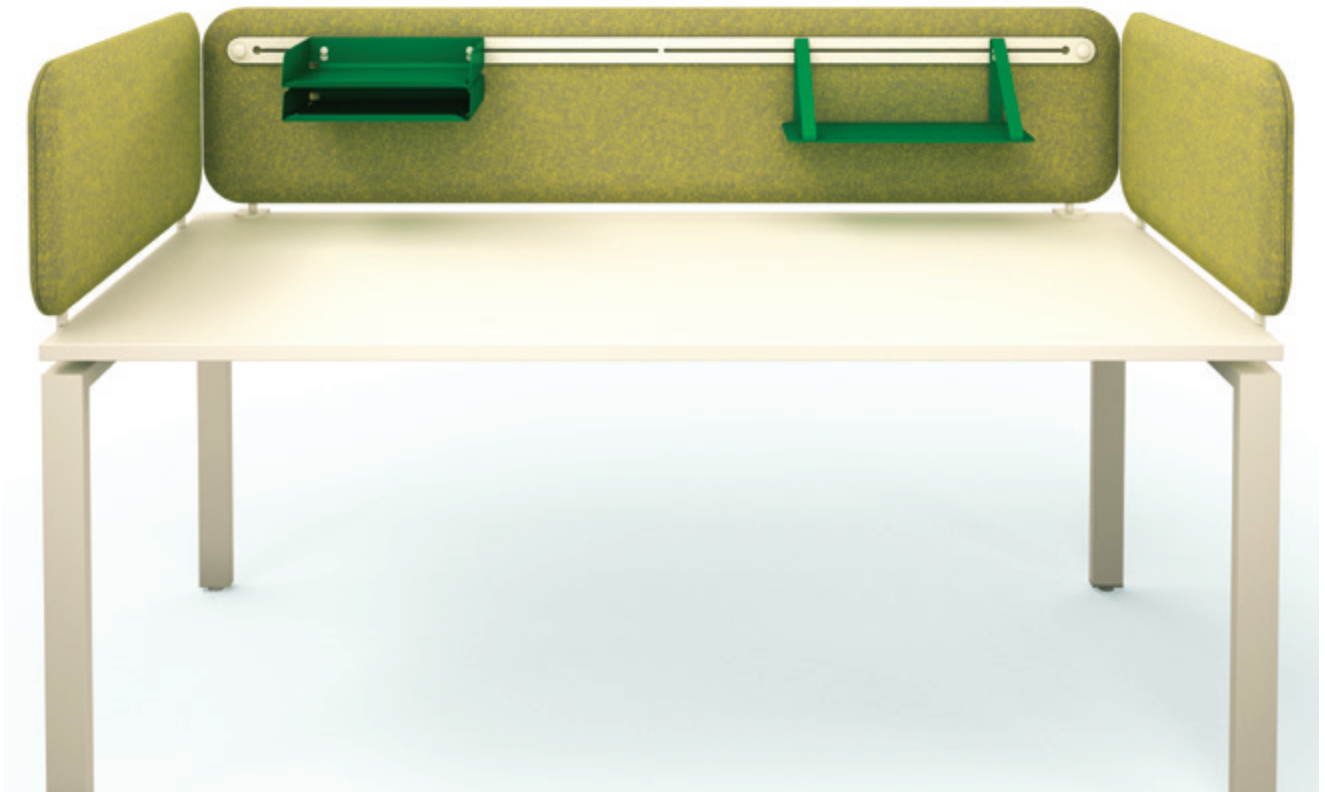

SOLANGE permet une délimitation de l'espace personnel sans pour autant isoler complètement le collaborateur de ses collègues. Les séparations visuelles et acoustiques SOLANGE s'intègrent facilement sur les bureaux individuels ou les bench, selon la configuration choisie.

SOLANGE allows users to define the boundaries of their personal workspace, without segregating themselves entirely from co-workers. Whether applied to individual or shared bench workstations, SOLANGE visual and acoustic partitions will fit seamlessly within any chosen configuration.

Met SOLANGE kan een persoonlijke werkplek afgebakend worden zonder de medewerker volledig te isoleren van zijn collega's. De visuele en akoestische afscheidingen zijn geschikt voor individuele of bench bureaus, naargelang de gekozen configuratie.





Pinces de fixation, différents modèles selon la configuration  
Fixing clamps, different versions required depending on the  
chosen configuration  
Bevestigingsklemmen, verschillende modellen naargelang  
de configuratie



Boutons esthétiques et fonctionnels pour fixer le rail  
Functional and aesthetically pleasing screw-on  
knobs used for attaching the accessory rail  
Elegante en functionele knoppen voor de bevestiging  
van de rail

**CLOISONS** STANDARD OU ACOUSTIQUES  
STANDARD OR ACOUSTIC **PARTITION SCREENS**  
STANDAARD OF GELUIDDEMPENDE **SCHEIDINGSWANDEN**



Disponibles en version standard ou acoustique, les cloisons SOLANGE structurent des zones privatives au sein d'un open space. Astucieuse, SOLANGE permet une reconfiguration presque infinie des espaces collaboratifs.

Available in both acoustic and standard versions, SOLANGE screens allow the structuring of an open space to accommodate smaller private areas. With its clever design, SOLANGE allows almost limitless possibilities when it comes to configuring shared workspaces.

De scheidingswanden SOLANGE zijn leverbaar in standaard- of geluiddempende versie. Hiermee kunnen afgescheiden werkzones gecreëerd worden in open space kantoren. Met hun vernuftige koppelsysteem bieden ze nagenoeg grenzeloze mogelijkheden voor de inrichting en herinrichting van de werkruimte.



Jeu de 2 pieds  
Différents modèles selon la configuration  
Set of 2 feet  
Different versions required depending on  
the chosen configuration  
Set van 2 poten  
Verschillende modellen naargelang de configuratie



Système de liaison pour relier 2, 3 ou 4 cloisons  
grâce aux boutons  
Connector kit allowing the linking of 2, 3 or 4  
partitions thanks to screw-on knobs  
Koppelset om 2, 3 of 4 wanden te verbinden met  
de knoppen



Paroi PMMA translucide pour cloison semi-vitrée  
Transparent PMMA panel for part-glazed partition screens  
Transparant PMMA-paneel voor half beglaasde wand

**PERSONNALISER SOLANGE**  
**CUSTOMISE SOLANGE**  
**SOLANGE PERSONALISEREN**



Afin de libérer la surface de travail et personnaliser son espace, SOLANGE propose une large gamme d'accessoires à suspendre et à coulisser sur un rail pour les panneaux écrans ou à poser directement sur la cloison.

To help free up space on worktops and provide a personal touch, SOLANGE carries an extensive range of accessories that can either run along a rail on the partition screen, or simply affix directly onto the panel.

Om de werkruimte vrij te maken en de werkplek te personaliseren, biedt SOLANGE ook een ruime keuze uit accessoires die verschuifbaar op een rail voor de privacy-panels of rechte reeks op de scheidingswand bevestigd worden.





Rail pour accessoires  
Accessory rail  
Rail voor accessoires



Bac à courrier départ/suivant  
Letter tray - starter/add-on  
Postbakje basis/opbouw



Étagère  
Shelving  
Legbord



Tableau magnétique  
Magnetic whiteboard  
Magneetbord



Jardinière 3 bacs  
Planter with 3 compartments  
Plantenhouders met 3 bakken



Plumier  
Pen tray  
Pennenbakje



Tableau écriture blanc PMMA avec plumier\*  
Whiteboard (PMMA) with pen tray\*  
PMMA whiteboard met pennenbakje\*

\*Compatible uniquement avec les cloisons - \*Only compatible with partition screens - \*Alleen geschikt voor scheidingswanden

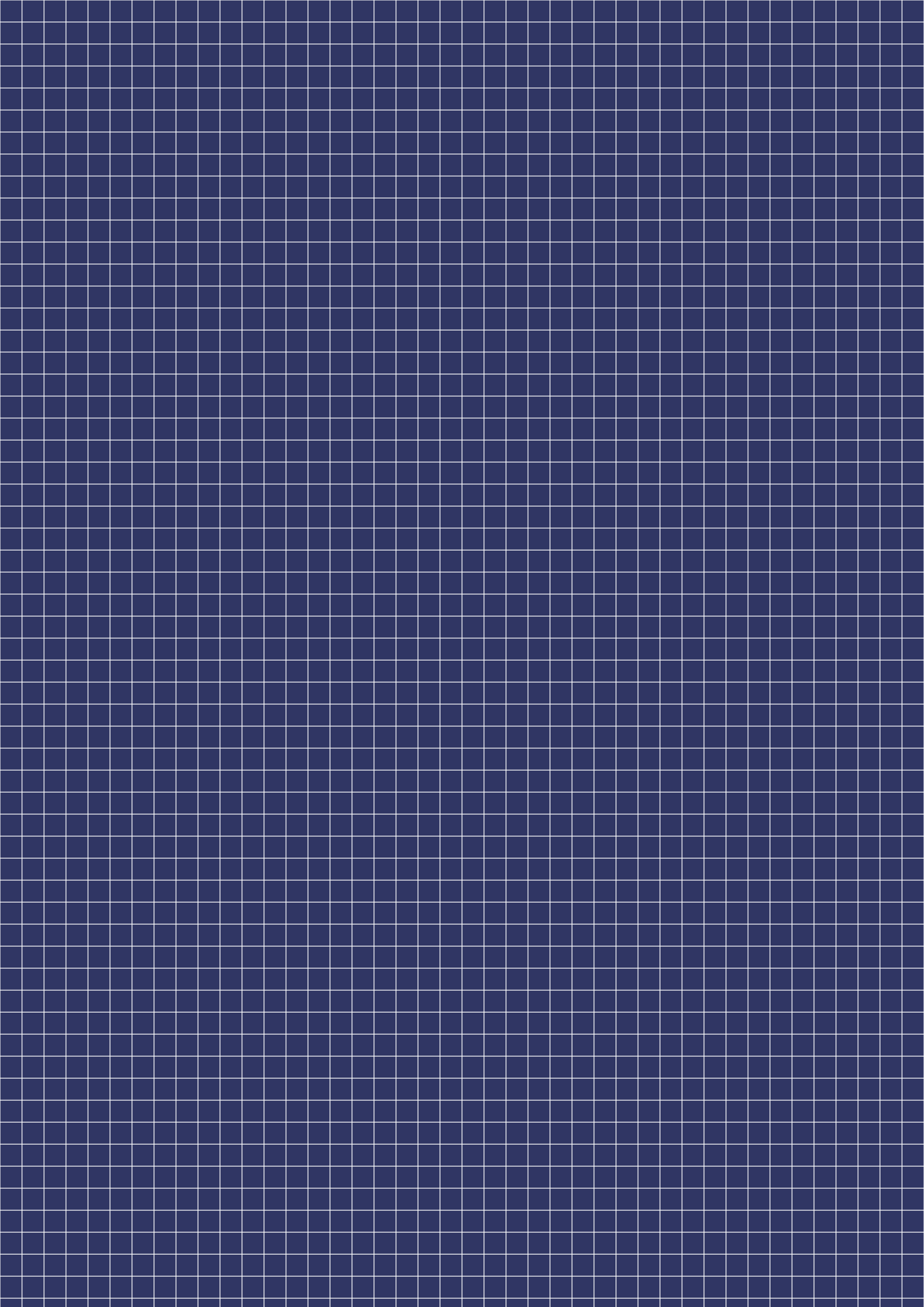

**SYNTHÈSE** & DIMENSIONS

—

**SUMMARY** & DIMENSIONS

**OVERZICHT** & AFMETINGEN

# GAMME RANGE COLLECTIE

Panneaux écrans acoustiques\* - Acoustic desktop screens\* - Geluiddempende privacy-panels\*



Panneaux écrans frontaux ou latéraux H. 400 mm  
Frontal or lateral desktop screens H. 400 mm  
Frontale of laterale privacy-panels H. 400 mm



Panneaux écrans frontaux H. 700 mm  
Frontal desktop screens H. 700 mm  
Frontale privacy-panels H. 700 mm

Pinces pour panneaux écrans\* - Clamps for desktop screens\* - Klemmen voor privacy-panels\*



Pinces frontales panneaux  
H. 400 mm  
Clamps for frontal attachment  
H. 400 mm  
Frontale klemmen voor  
panelen H. 400 mm



Pinces frontales panneaux  
H. 700 mm  
Clamps for frontal attachment  
H. 700 mm  
Frontale klemmen voor panelen  
H. 700 mm



Pinces latérales entre bureaux  
départ/suivant  
Lateral clamps for starter/  
add-on desks  
Laterale klemmen voor  
aanbouwbureau



Pinces latérales en extrémité  
Lateral clamps for desk ends  
Laterale klemmen voor  
bureau-uiteinde



Pinces bureaux en vis-à-vis  
Clamps for workstations  
positioned face-to-face  
Klemmen voor tegenover  
elkaar geplaatste bureaux



Pinces traversantes bench  
monoplateau  
Bolt-through clamps for  
shared worktop bench desks  
Klemmen door het blad voor  
enkel bench bureau

\*Pinces de fixation à commander séparément selon le type de configuration - \*Fixing clamps must be ordered separately in accordance with the chosen desk configuration - \*Klemmen afzonderlijk te bestellen naargelang de configuratie



Cloisons standard ou acoustiques\* - Standard or acoustic partition screens\* - Standaard of geluiddempende scheidingswanden\*

---



Cloisons tissu  
Fabric covered partition screens  
Stoffen scheidingswand



Cloisons tissu semi-vitrées PMMA translucide  
Part-fabric and part-glazed PMMA partition screen  
Scheidingswand met transparant PMMA-paneel

Pieds pour cloisons\* - Stabilizer feet for partition screens\* - Poten voor scheidingswanden\*

---



Pieds pour cloison seule  
Stabilizer feet for individual partition screen  
Poten voor vrijstaand paneel



Pieds pour cloisons multiples  
Stabilizer feet for multiple partition screens  
Poten voor samengestelde panelen



Pieds sur roulettes  
Castor-mounted stabilizer feet  
Poten op wielen

Système de liaison - Linking system - Koppelsysteem

---



Système de liaison pour relier 2, 3 ou 4 cloisons  
Connector kit: for linking of 2, 3 or 4 partitions  
Koppelsset om 2, 3 of 4 wanden te verbinden

\*Jeu de pieds à commander séparément selon le type de configuration - \*Set of stabilizer feet, must be ordered separately in accordance with the chosen configuration - \*Koppelsset afzonderlijk te bestellen naargelang de configuratie

# SYNOPTIQUE

## OVERVIEW

## OVERZICHT

### Panneaux écrans acoustiques\* - Acoustic desktop screens\* - Geluiddempende privacy-panels\*

Panneaux écrans frontaux ou latéraux H. 400 mm - Frontal or lateral desktop screens H. 400 mm - Frontale of laterale privacy-panels H. 400 mm

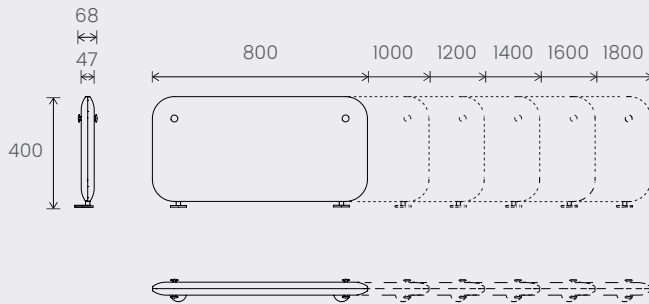

Les panneaux écrans L. 800 et 1000 mm peuvent être positionnés en version latérale pour les bureaux Prof. 800 et 1000 mm.  
 Desktop partition screens W. 800 and 1,000 mm may also be positioned laterally on desks with D. 800 and 1,000 mm.  
 De privacy-panels B. 800 en 1000 mm kunnen lateraal bevestigd worden aan bureaus diepte 800 en 1000 mm.

Panneaux écrans frontaux H. 700 mm - Frontal desktop screens H. 700 mm - Frontale privacy-panels H. 700 mm

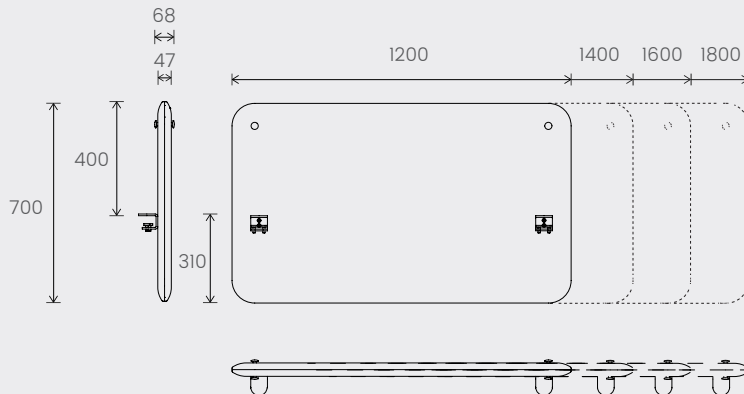

\*Pinces de fixation à commander séparément selon la configuration et le type de panneau écran  
 \*Fixing clamps must be ordered separately in accordance with the chosen configuration and the type of partition  
 \*Bevestigingsklemmen afzonderlijk te bestellen naargelang de configuratie en het type privacy-paneel

Cloisons standard ou acoustiques\* – Standard or acoustic partition screens\* – Standaard of geluiddempende scheidingswanden\*

Cloisons tissu – Fabric partition screens – Stoffen scheidingswanden

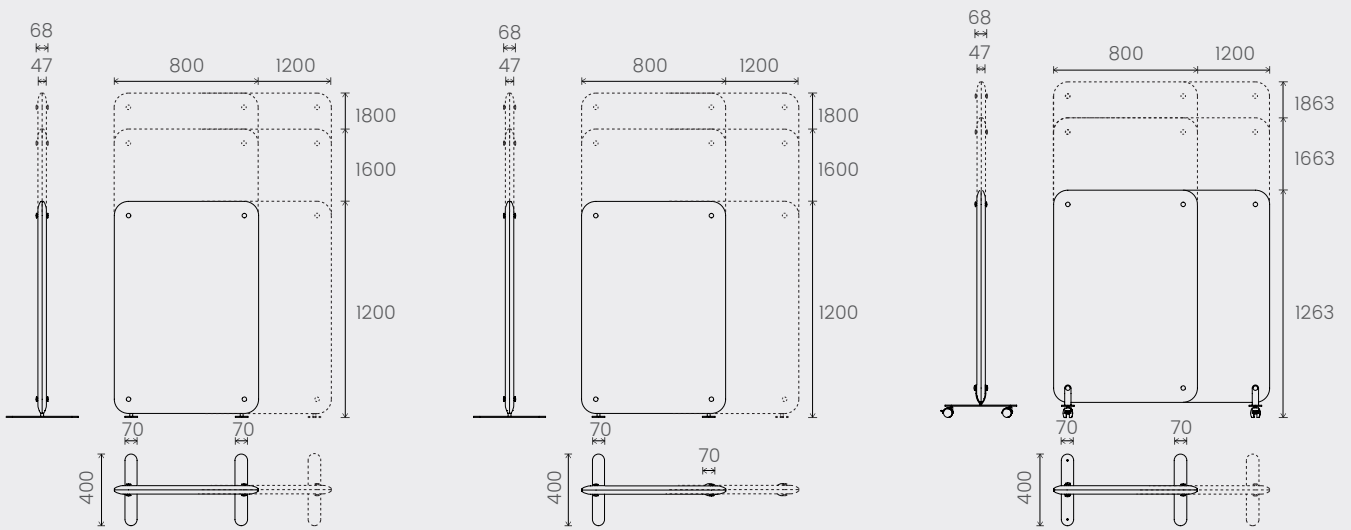

Cloisons tissu semi-vitrées PMMA – Part-fabric and part-glazed PMMA partition screens – Stoffen scheidingswanden met PMMA-paneel

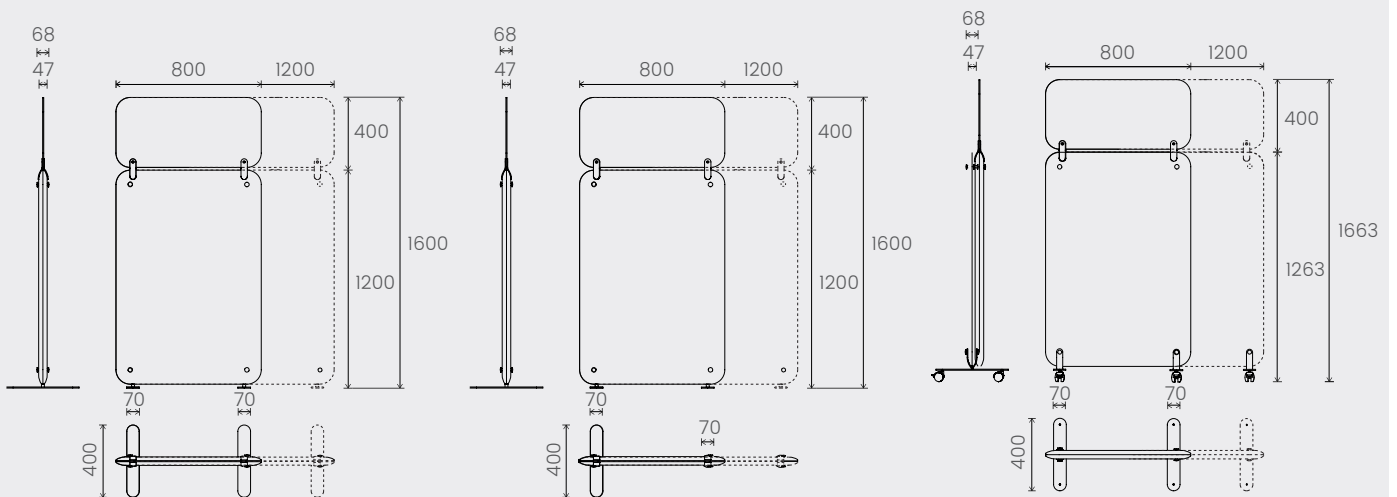

\*Jeu de pieds à commander séparément selon la configuration  
 \*Set of stabilizer feet, must be ordered separately in accordance with the chosen configuration  
 \*Potenset afzonderlijk te bestellen naargelang de configuratie

Accessoires pour panneaux écrans – Accessories for desktop screens – Accessoires voor privacy-panels

Rail pour accessoires – Accessory rail – Rail voor accessoires

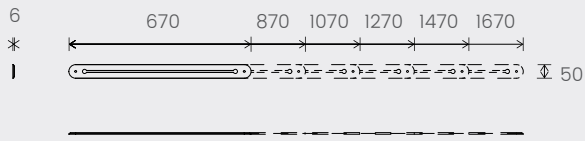

Bac à courrier départ/suivant – Letter tray – starter/add-on – Postbakje basis/opbouw



Tableau magnétique – Magnetic whiteboard – Magneetbord



Jardinière 3 bacs – Planter with 3 compartments – Plantenhouder met 3 bakken

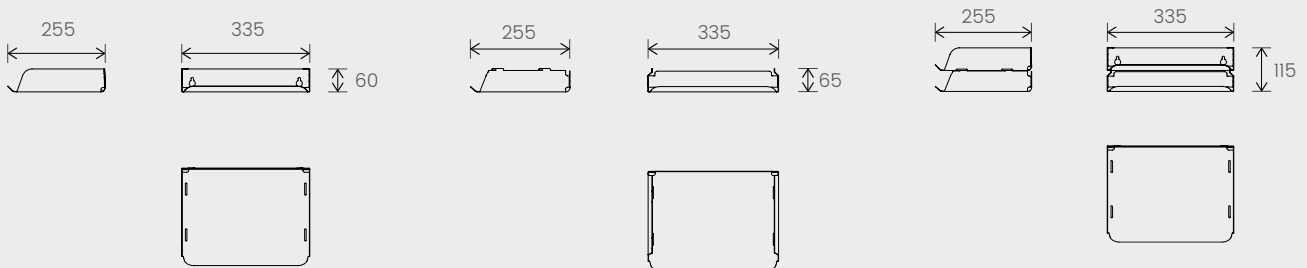
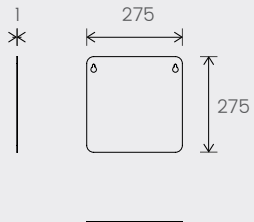
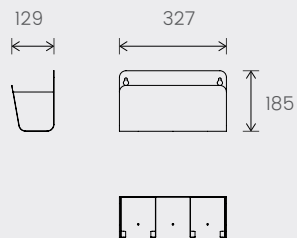

Etagère - Shelving - Legbord

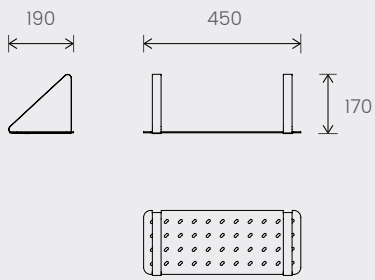

Plumier - Pen tray - Pennenbakje

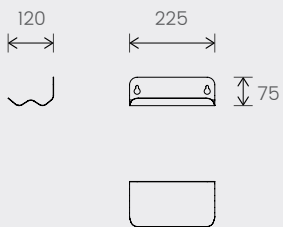

Accessoire pour cloisons - Accessories for partition screens - Accessoires voor scheidingswanden

Tableau écriture PMMA blanc avec plumier - Whiteboard (PMMA) with pen tray - PMMA whiteboard met pennenbakje

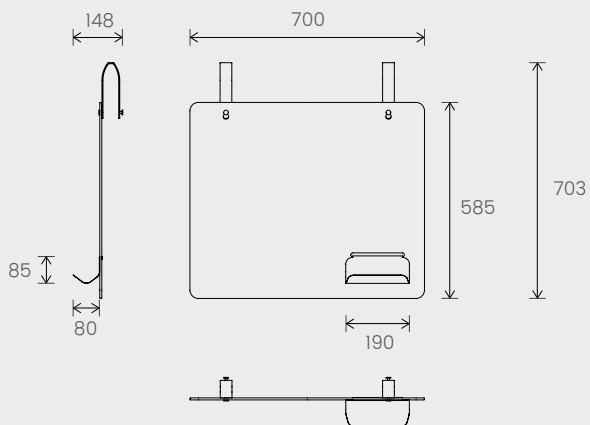

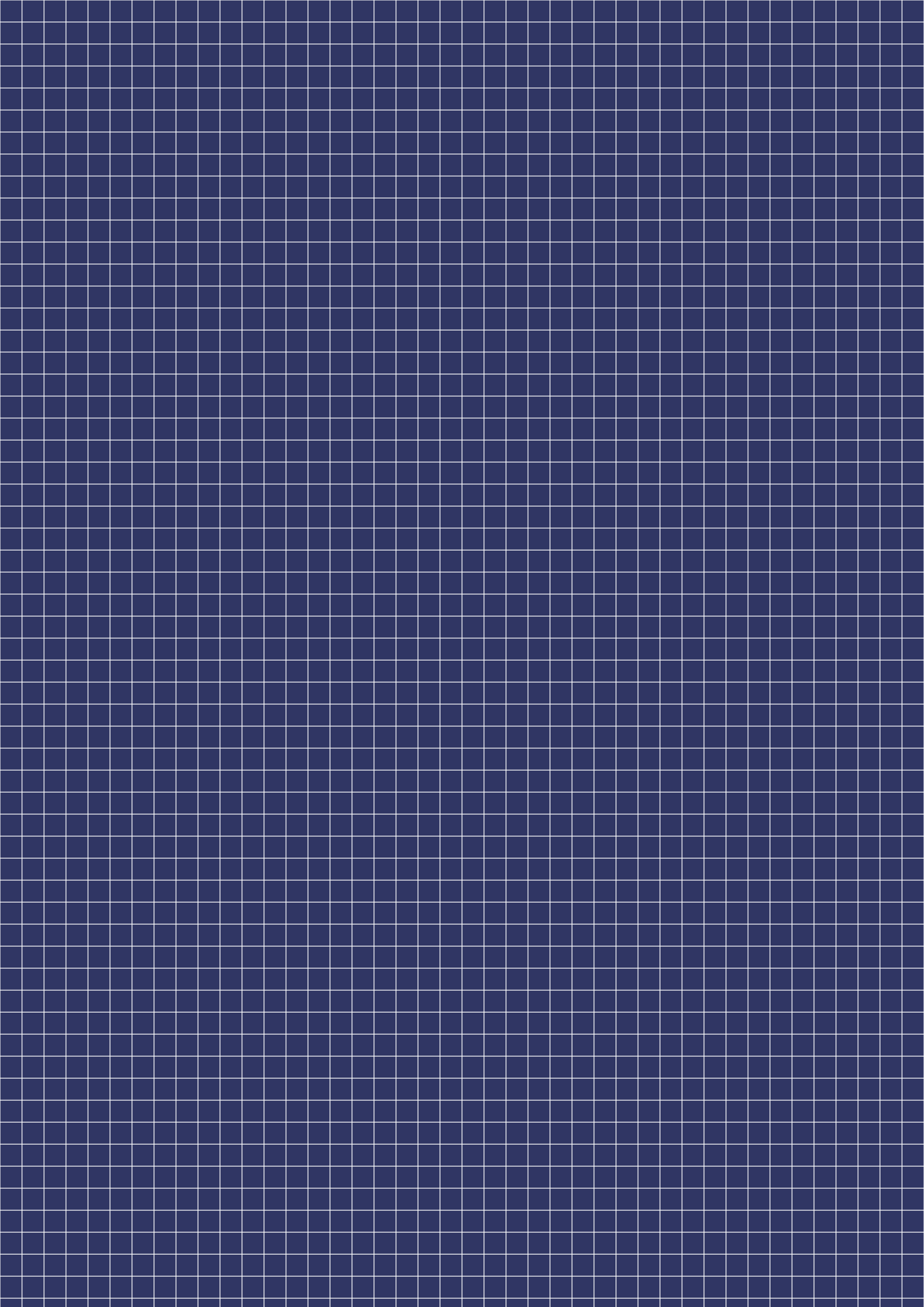

**MATIÈRES** & COULEURS

—

**MATERIALS** & COLOURS

**MATERIALEN** & KLEUREN

# 1. TISSUS - FABRICS - STOFFEN

## Bondai (100% polyester) - Cat A

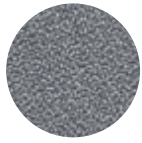

KD | Gris nuage  
Cloud grey  
Wolk grijs



KA | Gris orage  
Storm grey  
Storm grijs

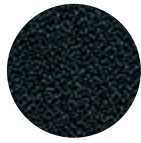

KE | Noir  
Black  
Zwart

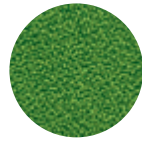

KF | Vert prairie  
Prairie green  
Weide groen

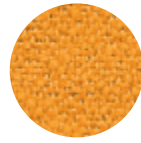

K4 | Jaune  
Yellow  
Geel

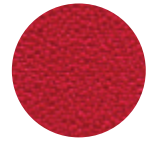

KZ | Rouge  
Red  
Rood



K6 | Bordeaux royal  
Royal bordeaux  
Bordeaurood



KG | Aubergine  
Aubergine  
Aubergine

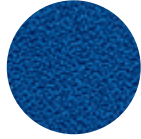

KC | Bleu électrique  
Electric blue  
Electra blauw

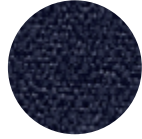

K2 | Bleu marine  
Navy blue  
Marine blauw

## Xtreme CS (100% polyester) - Cat B



U4 | Gris clair  
Light grey  
Lichtgrijs

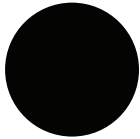

U5 | Noir  
Black  
Zwart



W3 | Gris beige  
Beige grey  
Beige grijs



W4 | Brun  
Brown  
Bruin



V6 | Jaune safran  
Saffron yellow  
Saffraan



U1 | Rouge vermillon  
Vermillion red  
Vermiljoen



V8 | Vert printemps  
Spring green  
Lente groen



W1 | Vert canard  
Duck green  
Vedergroen



W2 | Vert impérial  
Imperial green  
Keizergroen

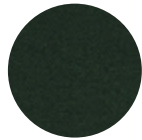

W5 | Vert brun  
Green brown  
Bruingrijs

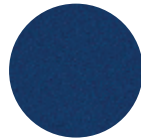

V1 | Bleu égyptien  
Egyptian blue  
Egyptisch blauw



W6 | Bleu nuit  
Midnight blue  
Nachtblauw

## Step (100% Trevira Cs) - Cat B

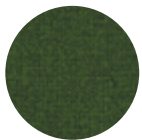

A1 | Bambou  
Bamboo  
Bamboe



A2 | Beige  
Beige  
Beige



A3 | Bleu marine  
Navy Blue  
Marine blauw



A4 | Bleu pétrole  
Petroleum blue  
Petroleum blauw

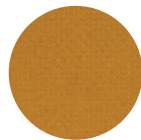

A5 | Jaune moutarde  
Mustard yellow  
Mosterd geel



A6 | Noir  
Black  
Zwart



A7 | Rouge cardinal  
Cardinal red  
Kardinaal rood

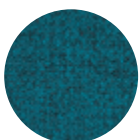

A8 | Turquoise  
Turquoise  
Turquoise



A9 | Vert anglais  
English green  
Engels groen



## Step mélange (100% Trevira CS) - Cat B

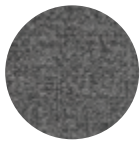

B1 | Anthracite chiné  
Mottled graphite grey  
Gespikkeld antraciet



B2 | Bambou chiné  
Mottled bamboo  
Gespikkeld bamboe

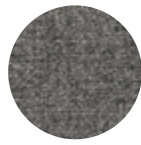

B3 | Beige chiné  
Mottled beige  
Gespikkeld beige

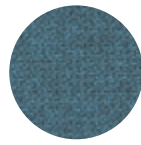

B4 | Bleu denim chiné  
Mottled denim blue  
Gespikkeld denim blauw

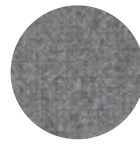

B5 | Gris clair chiné  
Mottled light grey  
Gespikkeld lichtgrijs

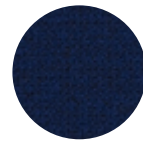

B6 | Marine chiné  
Mottled navy blue  
Gespikkeld marine blauw



B7 | Marron foncé chiné  
Mottled dark brown  
Gespikkeld donkerbruin

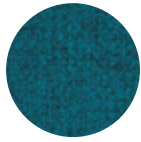

B8 | Turquoise chiné  
Mottled turquoise  
Gespikkeld turquoise



B9 | Violine chiné  
Mottled dark purple  
Gespikkeld violine

## Blazer (100% laine vierge - pure virgin wool - scheerwol) - Cat D

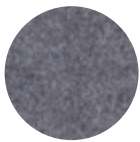

H6 | Gris moyen chiné  
Mottled medium grey  
Gespikkeld medium grijs



J8 | Gris foncé chiné  
Mottled dark grey  
Tweekleurig donkergrijs



HX | Jaune d'or  
Golden yellow  
Jaune d'or



J2 | Marron foncé chiné  
Mottled dark brown  
Gespikkeld donkerbruin

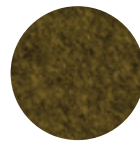

HA | Vert olive chiné  
Mottled olive green  
Gespikkeld olijfgroen



J9 | Vert impérial  
Imperial green  
Imperial groen

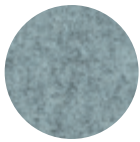

H9 | Bleu pâle chiné  
Mottled pale blue  
Gespikkeld pale blauw

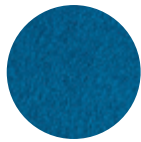

HQ | Bleu céleste  
Celestial blue  
Hemel blauw



J6 | Rouge Wellington  
Wellington red  
Wellington rood



JG | Rose Marsala  
Marsala rose  
Marsala roze

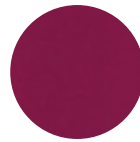

I3 | Bordeaux  
Bordeaux  
Bordeauxrood

## 2. MÉTAL (Pieds et pinces de fixation\*) - METAL (Stabilizer feet and fixing clamps\*) - METAAL (Poten en bevestigingsklemmen\*)

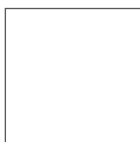

SO | Blanc  
White  
Wit

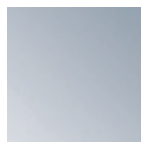

SA | Gris aluminium  
Aluminium grey  
Alugrijs



SC | Gris anthracite structuré  
Textured graphite grey  
Gestructureerd antraciet

\*Livrés avec les boutons ABS des panneaux écrans et cloisons. Coloris blanc pour pieds et pinces finitions SO/SA - Coloris anthracite pour finition SC

\*Clamps supplied together with the ABS screw-on knobs for desktop and partition screens. In white for feet and clamps in SO/SA finish - In graphite grey for SC finish

\*Geleverd met ABS knoppen van de privacy-panels en scheidingswanden.

Wit voor poten en klemmen met afwerking SO/SA - Antraciet voor afwerking SC.

### 3. MÉTAL (Rails et accessoires) – METAL (Rails and accessories) – METAAL (Rails en accessoires)



ZO | Blanc structuré  
Textured white  
Gestructureerd wit



SU | Gris souris structuré  
Textured mouse grey  
Gestructureerd muisgrijs



SC | Gris anthracite structuré  
Textured graphite grey  
Gestructureerd antraciet



ZP | Noir structuré  
Textured black  
Gestructureerd zwart



SO | Blanc  
White  
Wit



SA | Gris aluminium  
Aluminium grey  
Alugrijs

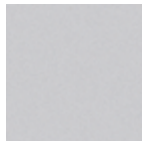

SD | Gris clair  
Light grey  
Lichtgrijs



SG | Noir  
Black  
Zwart



X2 | Gris platine  
Platinum grey  
Patina grijs



XI | Gris anthracite  
Graphite grey  
Antraciet



X8 | Vert pâle  
Pale green  
Bleek groen



X3 | Vert émeraude  
Emerald green  
Smaragd groen



X5 | Jaune tournesol  
Sunflower yellow  
Zonnebloem geel



X9 | Vieux rose  
Dusty pink  
Oud roze



Z3 | Laiton  
Brass  
Messing



X6 | Rouge carmin  
Carmine red  
Karmijn rood



Z1 | Rouge noir  
Red black  
Zwart rood



X4 | Bleu cobalt  
Cobalt blue  
Kobalt blauw



X7 | Turquoise pastel  
Pastel turquoise  
Pastel turquoise



Z2 | Bleu capri  
Capri blue  
Capri blauw



# SHOWROOMS

## **| PARIS**

171, Avenue des Grésillons - 92230 Gennevilliers  
Tel : +33 (0)1 47 33 47 37

## **| LONDON**

4th Floor - 14-18 Old Street - London EC1V 9BH UK  
Tel : +44 (0)203 794 66 07

## **| BRUXELLES**

81, Chaussée de Nivelles - 1420 Braine-l'Alleud  
Tel : +32 (0)2 894 99 80